

Mid-Western Ontario Horseman's Society Rulebook



1977 – 2023

Rulebook updated as of AGM 2022

TABLE OF CONTENTS

OBJECTIVES AND PRIORITIV	0.0	PAGE 3
BYLAW NUMBER ONE	1.0	PAGE 3
LOGO	1.1.....	PAGE 3
DIRECTORS	1.2.....	PAGE 3
OFFICERS	1.3.....	PAGE 4
COMMITTEES.....	1.4.....	PAGE 5
MEMBERS	1.5.....	PAGE 5
Types of Memberships	1.5.1.....	PAGE 5
Membership Fees	1.5.2.....	PAGE 6
Meetings of Member	1.5.3.....	PAGE 6
FISCAL YEAR	1.6.....	PAGE 5
PROBATION-SUSPENSION-EXPULSION	1.7.....	PAGE 5
BY-LAW NUMBER TWO	2.0	PAGE 8
GENERAL RULES	3.0	PAGE 8
HORSES	3.1	PAGE 8
TACK	3.2.....	PAGE 8
BITS	3.3.....	PAGE 9
ATTIRE	3.4	PAGE 12
DIVISIONS	3.5.....	PAGE 12
PROTESTS	3.6.....	PAGE 13
JUDGES	3.7.....	PAGE 13
RING STEWARDS	3.8.....	PAGE 14
SHOW CONDITIONS	3.9.....	PAGE 14
ENTRIES	3.10.....	PAGE 15
CONDUCT.....	3.11	PAGE 15
DISQUALIFICATIONS	3.12.....	PAGE 16
PERFORMANCE	3.13.....	PAGE 16
TIMED EVENTS	3.14.....	PAGE 16
HUMANE TREATMENT OF HORSES	3.15	PAGE 15
POINTS AND AWARDS	4.0	PAGE 18
APPROVED CLASSES	4.1.....	PAGE 20
NOVICE	1.5.1c	PAGE 6
.....	4.0.....	PAGE 18
.....	4.1.....	PAGE 20
		<u>MWHS Rulebook revised for above section 1999</u>
HALTER CLASSES	5.0	PAGE 20
		<u>MWHS Rulebook revised for above section 2013</u>
YEARLING LONGE LINE	6.0	PAGE 21
LEADLINE	7.0	PAGE 22
PERFORMANCE CLASSES	8.0	PAGE 22
ADULT SHOWMANSHIP AT HALTER	8.1	PAGE 22

ADULT HORSEMANSHIP.....	8.2.....	PAGE 22
WESTERN PLEASURE	8.3.....	PAGE 23
TRAIL HORSE	8.4.....	PAGE 24
ENGLISH PLEASURE	8.5.....	PAGE 31
ENGLISH EQUITATION	8.5.1.....	PAGE 31
JUNIOR HORSE WESTERN PLEASURE	8.3.....	PAGE 23
Equipment	3.3.....	PAGE 9
Judging	8.3.....	PAGE 23
Gates.....	8.3.....	PAGE 23
WESTERN RIDING	8.7.....	PAGE 31
Western Riding patterns	8.7.1.....	PAGE 36
REINING.....	8.8.....	PAGE 41
Reining Patterns	8.8.1.....	PAGE 43
RANCH RIDING	8.9.....	PAGE 60
Ranch Riding Patterns	8.9.1.....	PAGE 63
JUNIOR PERFORMANCE	9.0.....	PAGE 68
JUNIOR A SHOWMANSHIP	9.1.....	PAGE 68
Junior B Showmanship Patterns		PAGE 69
JUNIOR A ENGLISH PLEASURE	9.2.....	PAGE 68
JUNIOR A WESTERN PLEASURE	9.3.....	PAGE 68
JUNIOR A WESTERN HORSEMANSHIP	9.4.....	PAGE 68
JUNIOR B SHOWMANSHIP	9.5.....	PAGE 68
JUNIOR B WESTERN PLEASURE	9.6.....	PAGE 68
JUNIOR B EQUITATION (English/Western)	9.7.....	PAGE 68
JUNIOR B TRAIL.....	9.8.....	PAGE 68
JUNIOR B WALK/ JOG/ TROT.....	9.9.....	PAGE 69
SPEED EVENTS	10.0.....	PAGE 71
CLOVER LEAF BARREL RACE.....	10.1.....	PAGE 71
POLE BENDING.....	10.2.....	PAGE 72
KEYHOLE RACE.....	10.3.....	PAGE 72
FLAG RACE	10.4.....	PAGE 72
DOWN & BACK	10.5.....	PAGE 73
TEXAS SPEED & ACTION	10.6.....	PAGE 73
RESCUE RACE.....	10.7.....	PAGE 73
DOUBLE FIGURE EIGHT	10.8.....	PAGE 74
COMBINATION RACE	10.9.....	PAGE 74
JUNIOR SPEED EVENTS.....	11.0.....	PAGE 74
JUNIOR A & B CLOVER LEAF BARRELS	11.1.....	PAGE 74
JUNIOR A & B POLEBENDING	11.2.....	PAGE 74
JUNIOR A& B KEYHOLE	11.3.....	PAGE 74
JUNIOR A FLAG	11.4.....	PAGE 74
JUNIOR B DOWN & BACK	11.5.....	PAGE 74
YOUTH SCHOLARSHIP	12.0.....	PAGE 75

0.0 OBJECTIVES & PRIORITIES

1. Promotion of horse shows
2. Hold an All-Breed futurity
3. Education of the general membership through lectures, clinics, newsletters, meetings and seminars.
4. Organize social events – tours, trail rides, hockey etc. and other off season and summer events for general public.
5. Assist area horse clubs organize and promote horse related activities and other social functions.
6. To promote horsemanship among the youth and support the “Mid-Western Ontario Horseman’s Youth Society”.

MWHS Rulebook revised for above section 1997

1.0 BY-LAW NUMBER ONE

A by-law relating to the transaction of the business and affairs of the Society. Be it enacted, by the Directors of the Society as a by-law, thereof, as follows.

1.1 LOGO

The logo, an impression of which is stamped here, shall be the logo of the Society, and when used, shall be authenticated by the signature of the President and Secretary or by the signature of officers and other persons that the Board may appoint.



1.2 DIRECTORS

The affairs of the Society shall be managed by a Board of Directors, minimum of ten (10) and maximum of fourteen (14). Directors so elected shall retain their directorship for the entire Society year, with the exception of removal in accordance with the existing by- laws

QUORUM: No less than 50% of the elected directors.

QUALIFICATIONS FOR DIRECTORS: Only members in good standing will be eligible to be directors and must hold a valid Open Membership in the Society and must have reached his/her 18th birthday. A Family Membership is deemed the same as an Open Membership. Not more than one member of a family shall be eligible to stand on the Executive of MWHS although there may be a family member on the Executive and another family member stand as a director. Or a maximum of 2 family members that stand as a director in one year, provided that they have separate memberships.

MWHS Rulebook revised for above section 2016

ELECTION AND TERM: The directors shall be elected by the members at the Annual Meeting of the Society by secret ballot. Unless impossible, this meeting should be in the fall after the last show. Term of office will be from January 1 to December 31. If a member wishes to stand for the position of Director but is unable to attend the Annual Meeting, he/she may so indicate in writing.

MWHS Rulebook revised for above section 2003

VACANCIES: A director may vacate office at any time by written resignation. In event of a vacancy occurring on the Executive, the person with the next highest votes will be appointed. When there is a shortage of elected Directors the President has the right to appoint Directors for the remainder of the term with the board of Directors” approval by a 2/3 majority.

REMOVAL OF DIRECTORS: A director may be removed from office at any time by a resolution passed by at least two-thirds of the vote cast at an Executive Meeting of which notice of such resolution has been given, and the vacancy shall be filled as set out in vacancies above.

DIRECTOR'S MEETINGS: Director's meeting may be convened by the President or two Directors at any time at any place on at least five days' notice – delivered, mailed or telephone or electronic correspondence to each Director. The minutes of Director's meetings shall stand approved if no objection is raised within seven (7) days by anyone who was in attendance at that meeting. MWHS rulebook revised for above section 2020

- a. **Without Notice:** Director's meeting may also be held at any time and at any place without formal notice, if all the Directors are present or if absent, waive notice and consent to the holding of the meeting. No notice shall be necessary for the first meeting of the Board held after its election at the Annual Meeting.
- b. **Waiver and Consent:** Notice of any meeting or irregularity in any meeting or in the notice thereof may be waived by any Director. Any Waiver and consent must be written consent.
- c. **Notice of Motion:** Any resolution or notice of motion affecting policy, monetary or committee structure changes or any deputation's to be presented to the Directors or the Executive committee must be in the hand of the Secretary at least two weeks prior to the next regular meeting of the directors so it can be distributed to the Directors prior to the meeting.
- d. **Attendance:** Any Director missing more than two (2) consecutive Director's meetings may be dismissed from the Board. A director who cannot attend a meeting must advise the President or Secretary of his/her anticipated absence.

MWHS Rulebook revised for above section 1996

VOTING: At a meeting of the Board, each Director present shall have one Vote on every question and in the case of an equality of votes the Chairman of the board shall have one vote on every question and in the case of equality of votes the Chairman of the Board shall have a second or casting vote.

RESPONSIBILITY OF DIRECTORS: The Board of Directors shall have the power to conduct all business and affairs of the Society including; the removal of Directors', disciplinary acting and reinstatement, recommended by-law changes, membership fees and classifications.

1.3 OFFICERS

APPOINTMENT: There shall be a President, Vice-President, Treasure, two (2) Secretaries and other Officers as the Board of Directors may occasionally determine. The above officers shall be elected individually from the general membership at the Annual Meeting, prior to the election of the remaining Directors. A vacancy in the office of the President will move up the Vice-President. Vice-President, Treasurer and Secretaries may be elected from the Directors by the Directors or be appointed, should there be a vacancy.

PAST PRESIDENT: The immediate past President of the Society will hold office for the following year (s)

PRESIDENT: The President shall be the chief executive officer of the Society. He/she shall, if present, preside at the meetings of Society; shall see that all orders and resolutions of the Board are carried out; he/she and the Secretary and Treasurer shall sign all deeds or other formal documents and shall perform all other duties as are incident to the office of the President of the Society, or are required by the Directors.

VICE-PRESIDENT: The Vice-President shall be vested with all the powers and shall perform all the duties of the President in the absence or the disability or refusal to act of the President. He/ She shall also have such other powers and duties as may be assigned to him by the board.

MWHS Rulebook revised for above section 1996

SECRETARIES: There will be two Secretaries. The **Recording Secretary** shall have charge of the minutes' book of the Society and shall record the minutes of all the meetings of the Directors and any other proceedings as the Board may direct. Unless some other officer is specifically charged with the duty, he/she shall also keep or cause to be kept any books and

recordings as required by the Board. The Recording Secretary shall sign with the President or other signing officer of the Society any instruments that require Signature. The **Membership Secretary** shall have charge of handling the current year's membership applications, issuing membership cards and carrying out any prescribed duties as set out by the Board.

TREASURER: The Treasurer shall have the care and custody of all the funds and securities of the Society and shall deposit the same in the name of the Society in the bank or banks as the Board of Directors may stipulate. Unless some other officer is specifically charged with this duty, the Treasurer shall keep the books of account which the Society is required to keep.

RENUMERATION: The board may not accept remuneration for duties, but may be reimbursed for expenses incurred.

1.4 COMMITTEES: In addition to the general directorship previously described, there may be the following committees or other committees as deemed necessary:

Awards Committee, Banquet Committee, Fund Raising Committee, Social Committee, Membership Committee, Newsletter Committee, Points Committee, Publicity and Education Committee, Show and contest Committee, Horse Show committee, Disciplinary Committee, Rulebook Committee

The Board of Directors will be responsible for electing or appointing the Chairman of each committee. It is recommended that a Director sits on each committee, but need not be Chairman. The President of the Society automatically becomes a member of every committee. The Board may select or appoint all the members of the committees or may delegate this authority to the Board of Directors.

MWHS Rulebook revised for above section 1996, 2012, 2013

The Chairman of each committee will submit to the board

- a) their objectives with a list of priorities
- b) The terms of reference and jurisdiction
- c) A budget
- d) a schedule of proposed meetings, which will be attended only by members of that particular committee, except with the express approval of the Board of Directors upon receipt of a request accompanied by the reason for the necessity of the attendance. If approval is given, the Board may delegate additional authority to each committee.

Each Chairman of a committee will submit the name and address of every committee member to the Board within one month of his/her appointment.

1.5 MEMBERS

Application for membership shall be in writing. Each applicant, on becoming a member, agrees to be bound by the by-laws and all rules and regulations of the Society, including committees. The Society has the power to reject any application for membership.

1.5.1 TYPES OF MEMBERSHIP

a. Family Membership: The Family Membership shall be entitled to all the rights and privileges of the Society, except that this membership is entitled to two votes only. With the exception of a spouse, a person may not harbor under a Family Membership upon reaching his 19th birthday as of January 1st. Annual family membership fees must be paid. Family members must reside together and be supported by the household. Exceptions are students away at school and/or children living in the custody of another parent. Any other exceptions must be approved by the Board upon written request. Two members of a family must be present to have two votes, 1 member does not have two votes.

b. Open Membership: The Open member shall be entitled to one vote at all meetings of the Society and be entitled to participate equally in any distribution of the Society upon its dissolution. Annual membership fees must be paid.

c. Novice: Any age rider on a horse holding a Single or Family Membership may apply for a Novice Card provided he/she has not shown in 20 open or breed shows over the past five (5) years, nor received money for riding, training or judging. A completed Novice Application form, signed by a director, must be submitted and approved. Any person being denied Novice status will have thirty days in which to appeal the decision at a Board hearing. If still denied, he/she may appeal at the next General meeting. General membership decision is final. If Novice status is granted it is retro active to the date of the application. If a novice wins a High Point or Reserve in a division, other than Novice, or they have won High Point or Reserve Novice twice they are ineligible to apply for Novice status.

MWHS Rulebook revised for above section 2016,2022

d. Associate Member: The Associate member pays a nominal fee for which he/she receives all Society correspondence, but is not entitled to vote nor collect points at horse shows for year end awards.

e. Honorary Member: A Membership bestowed on a person, as recommended by the Board and approved by the general Membership

MWHS Rulebook revised for above section 2013

1.5.2 MEMBERSHIP FEES

All Fees may be subject to review by the Board of Directors at any time:

Family Membership - \$60.00

Open Membership - \$30.00

Associate Membership - \$15.00

1.5.3 MEETING OF MEMBERS

a. Annual Meetings; The Annual Meeting shall be held at a place and time designated each year by the Board of Directors or the President. Unless impossible, it should be in the fall of the year after the show season. Election of the Executive and amendments to the rules or Constitution can only take place at an annual meeting.

b. Special Meeting: Other General meetings may be convened by order of the President, Vice-President or the Board of Directors at any time and at any place.

c. With and Without Notice: Notice of the time and place of any meeting and the general nature of the business to be transacted shall be mailed to each member entitled to vote at the meeting at least ten (10) days prior to the date of the meetings. Annual General Meetings may be held at any time and at any place within our area without notice if all members entitled to vote are present. At such meetings, any business may be transacted as a regular annual or general meeting. Notice published in the Newsletter is considered proper notice, if mailed ten (10) days prior to the meeting.

MWHS Rulebook revised for above section 2010

d. Waiver: Notice of any irregularity in the notice may be waived by any member. The Waiver may be in written form.

e. Voting: At all meetings or polls, every voting member present or by written proxy, shall have one vote on a show of hands or by secret ballot. Changes to rules or constitution require two-thirds of the total votes cast to be in favour for the motion to be passed. Proxies not allowed for Rule changes.

MWHS Rulebook revised for above section 2010

f. Quorum: A quorum of any general or annual meeting shall consist of a minimum of fifteen (15) voting members.

g. Order of Business: Business will be conducted according to Robert's Rules of Order, or as follows:

- 1) Call to order and reading of notice of meeting.
- 2) Identification of members and establish a quorum
- 3) Reading of minutes of previous meeting
- 4) Treasurer's Report
- 5) Reports of Officers, Directors and Committees
- 6) Correspondence
- 7) Unfinished business
- 8) President's report
- 9) Election of directors
- 10) New business
- 11) Adjournment

1.6 Fiscal Year

The fiscal year of the Society shall be from January 1st to December 31st each year.

NSF CHEQUES: a \$25.00 charge for NSF cheques will be levied and points will not accumulate until the member is in good standing.

MWHS Rulebook revised for above section 2006

BILL PAYMENT: A bill must be paid within one calendar year of said occurrence of the bill in question in order for it to be considered for payment. All bills that are not submitted within the calendar year will not be considered to be valid unless deemed so by the board due to an extenuating circumstance for the bill not to have been submitted within the calendar year.

MWHS Rulebook revised for above section 2010

1.7 PROBATION, SUSPENSION, EXPULSION

The Board of Directors shall have the power to place on probation, suspend or expel any member who fails to observe any rule or regulation set forth in these by-laws or whose conduct is, in the opinion of the Board, prejudicial to the Society.

Prior to the Board of Directors exercising its authority to place on probation, suspend or expel a member, the member shall first have received notification of the breach or charge being brought against him/ her and shall have an opportunity to answer such charge. Notification shall be in writing sent by prepaid post to the address last noted with the Society, and shall state the time and place of the hearing. The member charged has the right to appear in person or with counsel to address the Board of Directors to answer the charge. In the event that the member does not appear in person or in counsel on the date set for the hearing, the Board may proceed in his/her absence.

A member placed on **PROBATION** shall be given a designated time for that probation and after the expiration of that time shall be reinstated automatically. A member on probation shall be denied the privilege of voting during that period of time he/she is on probation

Non-payment of any account with the Society for a period of ninety (90) days, shall result in automatic **SUSPENSION** from the Society until the arrears are paid in full. The member may then be reinstated at the discretion of the Board.

After the Expiration of sixty (60) days, the suspended member has the right to apply for reinstatement in writing or by membership application to the Board of Directors, and may be reinstated at the meeting of the Board if two-thirds of the members present, vote in the affirmative. A suspended member is denied all privileges of the Society with the exception that he/she will receive all publications and notices due paid members during that period of suspension that the member has paid.

EXPULSION shall be for a specified period of time, not less than one year in duration. After which the expelled person has the right to apply for reinstatement in writing to the Board of Directors, and may be reinstated at the meeting of the Board, provided that two-thirds of the members present vote in the affirmative. An expelled member is denied all privileges of the Society.

MWHS Rulebook revised for above section 1996

If the Board of Directors refuses to reinstate a person suspended or expelled from membership, that person has the right to apply for reinstatement at the next General Meeting. Reinstatement requires an affirmative vote by two – thirds of the members present and voting.

2.0 BY LAW NUMBER TWO

That all members of the Mid-Western Horseman's Society be governed by and follow the guidelines as outlined in the current Mid-Western Ontario Horseman's Society Rulebook

MWHS Rulebook revised for above section 1996

3.0 GENERAL RULES

ANY ADDITION OR AMENDMENT TO THE MWHS RULES MUST BE VOTED ON BY THE GENERAL MEMBERSHIP AT THE ANNUAL MEETING AND PASSED BY A TWO THIRDS MAJORITY. ANY CHANGES WILL NOT GO INTO EFFECT UNTIL THE NEXT CALENDAR YEAR OR SHOW SEASON. CHANGES ARE NOT RETROACTIVE.

The following rules apply to ALL classes or events. Failure to comply with them will result in disqualification. Horses and equipment may be examined by the Judge or MWHS representatives.

MWHS Rulebook revised for above section 2015

3.1 HORSES

Unless otherwise specified. Ponies are considered horses.

- a. A horse may be serviceably sound and properly groomed to be eligible for any MWHS approved class.
- b. All horses doctored in any way, improperly or unfairly prepared, or tampered with before coming into the show ring will be disqualified and forfeit all points earned for the current season and MWHS current MWHS membership until reinstated by the Board of Directors.
- c. All ponies are to be measured at the first MWHS show they attend. Any horse or pony that is measured by the MWHS with flat shoes or bare feet will be issued a card recording the height with two signing Directors, and will be valid for the current show season.

MWHS Rulebook revised for above section 2008

- d. The age of a horse will be as of January 1st of the year foaled. A junior horse is 5 years of age or under unless otherwise stated.
- e. Stallions may not be shown, ridden or handled by any exhibitor under 19 years of age as of January 1st of the current year.

MWHS Rulebook revised for above section 2012, 2014

3.2 TACK

- a. Horses to be shown in serviceable western tack (silver not to count), including western or English saddle with standard rigging and girthing.
- b. Martingales and tie-downs are prohibited in all performance classes. Tapaderos are prohibited in all classes except Junior B.
- c. Protective boots, leg wraps or bandages are optional in reining, ranch horse pleasure, western riding, horsemanship, English Equitation and speed events.
- d. All speed events are to be executed in western tack and attire.
- e. Easy Boots are allowed in all classes.

MWHS Rulebook revised for above section 2004, 2009, 2014, 2015

3.3 BITS

- a. Any Junior horse or pony 5 years or under may be shown in a snaffle bit or bosal. Any pony regardless of age may be shown in a snaffle bit. Rider must ride with two hands in all performance classes if snaffle bit or bosal is used. Refer to Snaffle bit rules.
- b. Bosals used by a junior horses or ponies must be flexible and may have flexible cable core but absolutely no rigid material under jaw or over nose, not matter how padded covered. A braided rawhide or leather bosal may be used in lieu of a snaffle bit, no larger than $\frac{3}{4}$ " (19 mm) diameter at the cheek. There must be a minimum of two finger spaces (approximately $1\frac{1}{2}$ " (3.8 cm) between bosal and the nose.
- c. Reference to Snaffle bits in Western Performance classes mean the conventional O-ring, egg-butt or D-ring with a ring no larger than 4" (10 cm) and no smaller than 2" (5cm). The inside circumference of the ring must be free of rein, curb or headstall attachments with would provide leverage. The mouthpiece should be round, oval or egg-shaped, smooth and unwrapped metal. It may be inlaid, but smooth or latex-wrapped. The bars must be a minimum of $\frac{5}{16}$ " (98mm) in diameter, measured one (1) inch (25 mm) in from the cheek with a gradual decrease to center of the snaffle. The mouthpiece may be two or three pieces. A three piece, connecting ring of $1\frac{1}{4}$ " (32 mm) or less in diameter, or a connecting flat bar of $\frac{3}{8}$ " to acceptable. Optional loose leather curb strap. Reins must be attached above the curb strap.
- d. Martingales, nosebands and tie downs are prohibited.
- e. Horses five (5) years old and younger may be shown in a snaffle bit, hackamore, curb bit, half-breed or spade bit. Horses six (6) years old and older must be shown in a curb bit, half-breed or spade bit. Reference to Bit in Western Performance classes mean the use of a curb bit that has a solid or broken mouthpiece, has shanks and acts with leverage. All curb bits must be of mechanical device and should be considered a standard western bit.

A description of a legal, standard Western Bit includes:

1. $8\frac{1}{2}$ " (215 mm) maximum length shank to be measured as indicated in the diagram. Shanks must be fixed.
 2. Concerning mouthpieces, bars must be round, oval or egg-shaped, smooth and unwrapped metal of $\frac{5}{16}$ " to $\frac{3}{4}$ " (8mm to 20mm) diameter, measured 1" (22mm) from the cheek. They may be inlaid, but smooth or latex wrapped. Nothing may protrude below the mouthpiece (bar) such as extensions or prongs on solid mouthpieces. The mouthpiece may be two or three pieces. A three-piece, connecting ring of $1\frac{1}{4}$ " (32mm) or less in diameter, or a connecting flat bar of $\frac{3}{8}$ " to $\frac{3}{4}$ " (10mm to 20mm), measured top to bottom with a maximum length of 2" (50mm), which lies flat in the horse's mouth is acceptable.
 3. The port must be no higher than $3\frac{1}{2}$ " (90mm) maximum, with rollers and covers acceptable. Broken mouthpieces, half-breeds and spades are standard.
 4. Slip or gag bits, and donut and flat polo mouth pieces are NOT acceptable.
- f. When a curb bit is used, a curb strap or curb chain is required, but must meet the approval of the judge. It must be at least $\frac{1}{2}$ " (15mm) in width and lie flat against the jaw of the horse. A broken strap or chain is not necessarily cause for disqualification.
 - g. In all English classes, an English snaffle (no shank), Kimberwick, Pelham and/ or full bridle (with two reins), all with Cavesson noseband and brow band may be used.
 1. In reference to mouthpieces, nothing may protrude below the mouthpiece (bar). Solid and broken mouth pieces may have a port no higher than $1\frac{1}{2}$ " (40mm). On broken mouthpieces only. Connecting rings of $1\frac{1}{4}$ " (32mm) or less in diameter or connecting flat bar of $\frac{3}{8}$ " to $\frac{3}{4}$ " (10mm to 20mm), measured top to bottom with a maximum length of 2: (50mm), and which lie flat in the horse's mouth are acceptable. All mouthpieces must be a minimum or $\frac{5}{16}$ " (8mm) in diameter to be measured 1" (25mm) in from the cheek or ring. Any bit having fixed headstall and/ or fixed rein requires the use of a curb chain. Smooth round,

oval or egg-shaped, slow twist, corkscrew, single twisted wire, double twisted wire mouthpieces and straight bar or solid mouthpieces with a maximum of 1 1/2" (40mm) high ports are allowed.

- 2. Bits of any style (Pelham, snaffle, Kimberwick) featuring mouthpieces with cathedrals, donuts, prongs, edges or rough, sharp material shall be cause for disqualification. If a curb bit is used, the chain must be at least 1/2" (15mm) in width and flat against the jaw of the horse.
- h. In timed events, any humane type of bit or hackamore may be used on horses of all ages.
- i. During the warm up period, horses must be ridden with the same equipment as required in the class.

MWHS Rulebook revised for above section 2001, 2014, 2015

Typical examples of acceptable bits



Carriage of reins (light contact)

Examples of Acceptable Hand Positions

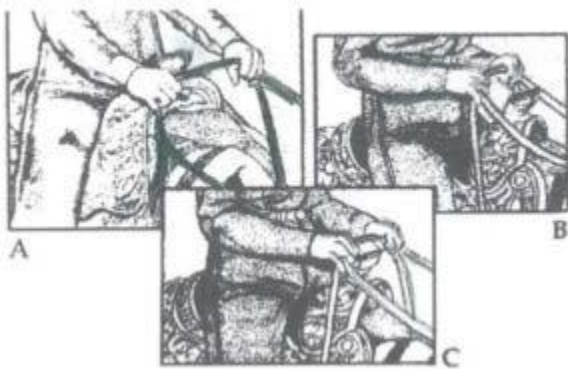

Examples of Unacceptable Hand Positions

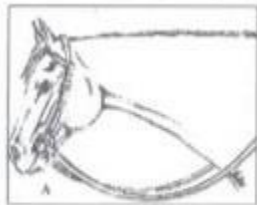
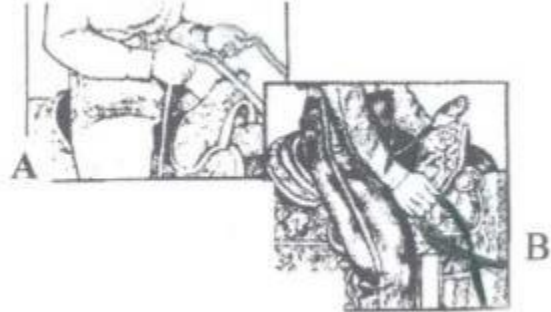

Acceptable

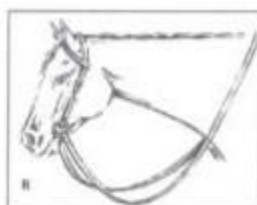

Too Loose

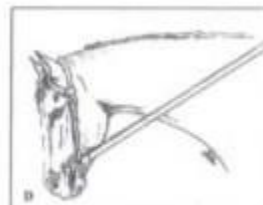

Too Tight

Some examples of acceptable English bits for all ages

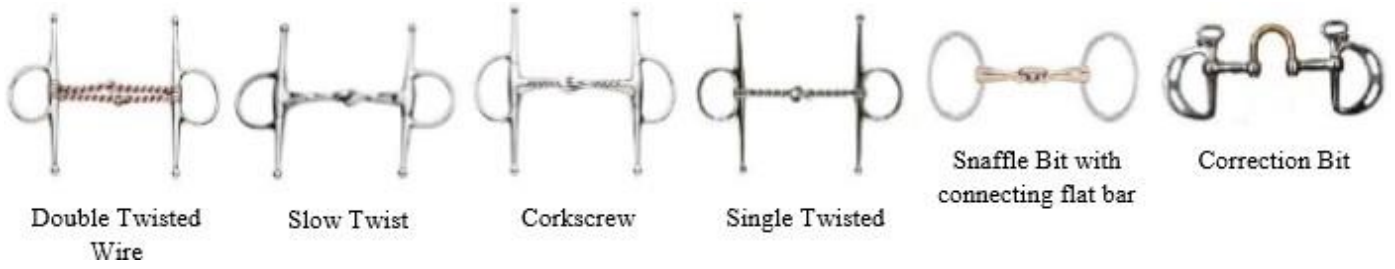

Some examples of unacceptable English bits



Some examples of acceptable chin straps



Western bits

Legal Bit

Illegal bit

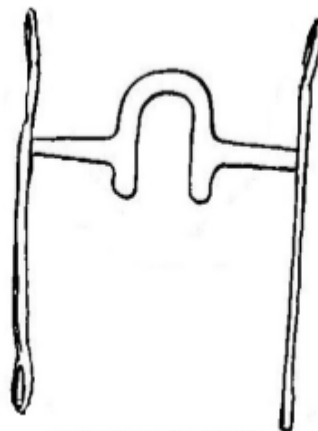
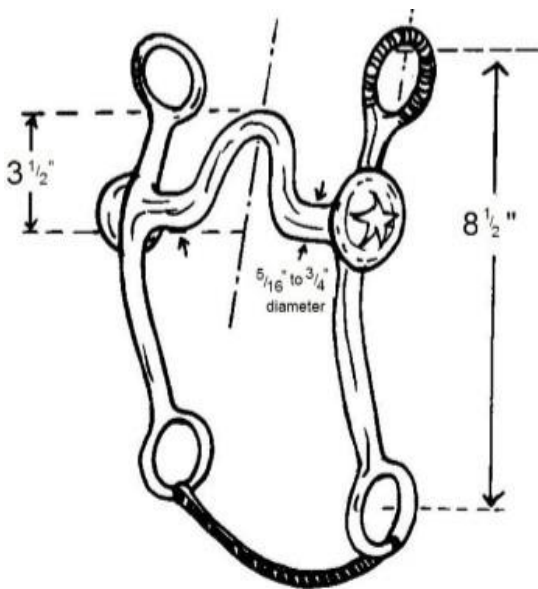

PRONG BIT

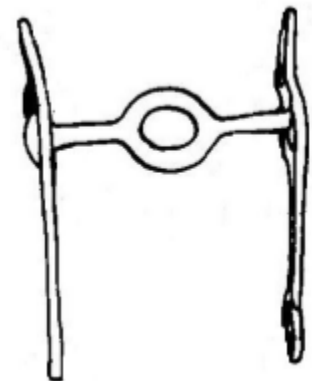

DONUT BIT

3.4 ATTIRE

- a. Rider to be dressed in suitable western attire including western hat or protective headgear; western or tailored shirt or sweaters (no sleeveless or capped sleeve shirts or blouses); boots; chaps; frontier pants or denims and optional belt. Tie, scarf or necklace is optional. Shirts or blouses are to be tucked in. All clothing must be neat and clean. For warm up classes, proper attire for that class must be worn.

MWHS Rulebook section above revised 2008, 2013 & 2015

- b. In all English classes, hunt seat riders should wear hunt coats in traditional colours such as navy, dark green, gray, black or brown. Breeches (or jodhpurs) are to be of traditional shades of buff, khaki, canary, light grey or rust, boots are to be black or brown. Exhibitors riding saddle seat must wear appropriate saddle seat attire including derby. Black, navy or brown hard hat is mandatory for all hunt seat riders. A tie or choker is required. Gloves, spurs of the unrolled type and crops or bats are optional. All manufactured English riding crops are not to exceed the length of 30" (76 cm). Hair must be neat or contained (as in a net or braid). Approved English helmets must be worn by Jr. A and Jr. B riders in English Pleasure or English Equitation classes.

MWHS Rulebook section above revised 2009 & 2015

- c. Judges, at their discretion, may authorize adjustments to attire due to weather related conditions.

3.5 DIVISIONS

HALTER: Horses or ponies to be shown on line and judged for conformation. They may be shown by seniors, juniors or novices. Juniors may not show stallions.

Open: Any exhibitor showing a horse over 13.2 hands. A current family or single MWHS membership is necessary to accumulate points.

MWHS Rulebook section above revised

- c. **JUNIOR A:** Any exhibitor 18 years of age or under as of January 1st. of the current year, showing a horse over 13.2 hands (54" or 137 cm+). A current MWHS family or single membership is necessary to accumulate points.

JUNIOR B: Any exhibitor 12 years of age or under as of January 1st. of the current year, showing a pony 13.2 hands (54" or 137 cm) or under, except in Walk/Jog classes. A current MWHS family or single membership is necessary to accumulate points. Ponies are to be measured by a MWHS director at their first show, height to be recorded and other pertinent information to be included in the show package.

MWHS Rulebook section above revised 2003, 2017

- e. **LEAD LINE:** Any exhibitor 7 years of age or under as of January 1st. of the current year, to be lead on a horse or pony by a handler 14 years of age or older as of January 1st. of the current year. Only the rider must hold a current MWHS family or single membership to accumulate points. An office fee will be charged to exhibitors.

NOVICE: Any age exhibitor showing a horse 14 hands or over. A current MWHS family or single membership and a Novice approval are necessary to accumulate Novice points in all senior classes. To exhibit in a Novice class, the exhibitor must complete and sign a Novice eligibility form.

Novice Western Pleasure class only - a novice rider may choose to ride any age of horse in a ring snaffle bit or bosal with two hands, otherwise if riding in a shank bit, they must ride with one hand.

- g. **ADULT:** Any Exhibitor 19 years of age or over as of January 1, riding a horse over 13.2 hands.

MWHS Rulebook section above revised 2015, 2016, 2022

3.6 PROTESTS

Any protest must be submitted in writing to the MWHS Show and Contest Committee, accompanied by a \$25.00 fee. The fee will be returned only if the protest is upheld.

3.7 JUDGES

- a. The Judge is to be dressed in suitable western attire and the Judge's decision is final.
- b. Speed events can be judged by a show official instead of a Judge who is given the power and same authority of a Judge on approval of the board in advance with a pre-approved list established when there are two rings being used.
- c. The Judge may order any person or horse from competition for bad conduct of exhibitor or horse. Such person may also be suspended from further competition during that show at the discretion of the Judge.
- d. It is mandatory that all the MWHS approved show Judges and Ring Stewards know and adhere to the rules and regulation of the Society.
- e. All Judges and Ring Stewards have the authority to request the removal or alteration of any piece of equipment or accessories.
- f. A judge may officiate at a maximum of two (2) shows per year if, another judge that has been booked for a show has an unforeseen circumstance arise and cannot attend the show he/she has been hired for. .
MWHS Rulebook section above revised 2004 & 2009, 2023
- g. A Judge cannot judge a MWHS approved show during the year in which he/she or a member of his/her family is competing for points.
- h. No horse shall be shown before a Judge officiating at an MWHS approved show that has been sold by that Judge within a period of 3 months prior of the date of the show.
- i. Following the announcement of an MWHS approved show's judge, exhibitors may not show a horse under that Judge if they have engaged in a financial transaction in connection with horses with that Judge within a period of 3 months prior to the date of the show.
- j. Exhibitors may not show before a Judge from whom they have leased a horse unless the lease is terminated at least three months prior to the date of the show.
- k. No youth or adult may compete in a class in which horsemanship is a factor before a Judge by whom they have been instructed, coached or tutored with or without pay, within three months prior to the date of the show. MWHS clinic and speed participants are exempt.
MWHS Rulebook section above revised 2016
- l. No youth may compete at an MWHS approved show before a Judge with whom his/her parents or guardians have had a financial transaction in connection with the sale or lease of a horse within 12 months prior to the date of the show.
- m. It is not permissible for a Judge to discuss the sale or lease of any horse during the continuation of a show at which he/she is officiating.
- n. A Senior Judge officiating at a MWHS approved show must have one calendar year elapse between showing or judging at an MWHS show. Current exhibitors are discouraged from judging the MWHS circuit.
MWHS Rulebook section above revised 2016
- o. If a scheduled judge does not arrive, the show committee and available MWHS directors will do their best to get a qualified person to judge the show and points will be with held until the judge's credentials have been verified and approved.
- p. Once a class has been judged, it shall not be re-judged. Once the Judge(s) has marked his/her card(s) and places for awards recorded or announced there shall be no change of the Judge's record, unless done through proper procedures of protest to the MWHS Board of Directors.
MWHS Rulebook section above revised 1997

3.8 RING STEWARDS

- a. A competent Ring Steward will be dressed in appropriate western attire and is required at all MWHS approved shows. Any reputable person may act in the capacity of Ring Steward who can furnish proof that he/she is capable through ability or experience and is familiar with the MWHS rules.
- b. A good Ring Steward makes the work of the Judge much easier by relieving him/her of unnecessary details. By assembling the class promptly, the Ring Steward will be able to keep the judging program on schedule and eliminate delays between classes.
- c. The Ring Steward will notify the Judge when all the horses are present for each class and call attention the horses that are absent. This information will then be placed on the record which the Steward marks after each class has been judged.
- d. The Ring Steward must keep in mind that he/she is to help the Judge – not to advise. Ring Stewards shall refrain from discussing or seeming to discuss the horses or exhibitors with the Judge. Ring Stewards shall not take part or seem to take part in any of the judging. When he/she is not actively engaged in his duties, the Ring Steward shall move into such a position so as not to interfere with the judging and the view of the spectators. He/she must not allow the exhibitors to crowd up in the ring and should at all times keep the possibility of an accident to a minimum.
- e. The Ring Steward has charge of the activity in the ring and should act as a mediator between the Judge and the exhibitor. The judge should request the Ring Steward to move and place the horses as he/she advises. When the ring is small and the class entries are large, the Ring Steward should take every precaution in keeping the horses moving until the Judge is ready for them to be judged and has the authority to ask an exhibitor to remove his/her horse for the safety of other horses or spectators.
- f. A competent Ring Steward can control the conduct of the horses and exhibitors in the ring, keep the classes progressing and is familiar with the rules and regulations of the MWHS. The Ring Steward has the authority to remove unsportsmanlike exhibitors from the ring.

MWHS Rulebook section above revised 2004 & 2014

- g. The Ring Steward must be familiar with the procedure of sifting when the classes are too large and the Judge requests that they be lined up for the first sift, the second sift, etc. until the Judge has the class ready.
- h. The Ring Steward shall place the winners the same in every class – 1 through 10 so that the spectators know how the horses place. After the ribbons have been handed out, the Ring Steward may have ribbon winners circle the ring for the benefit of the spectators.

3.9 SHOW CONDITONS

- a. To hold a MWHS approved show, a show approval form must be submitted, approved and adhered to.
- b. The MWHS recommends a minimum ring size of 100' by 200' (30.5 m x 61m). Ring is to be safely enclosed. At the discretion of the Show Manager and MWHS Horse Show/Show & Contest Committee a second ring may be cordoned off for trail, showmanship and/or halter classes when conditions allow or are necessary. The area is to be marked off to stop spectators etc. from walking through.
- c. In all classes, unless conditions warrant, the entire ring is to be used unless the Judge and show committee deem unsafe conditions.
- d. No classes may be added or deleted after a show has received approval without the written permission of the Show and Contest Committee.
- e. In all events, Junior A must run the same course as Senior.
- f. MWHS shows will be approved to run from Friday 6:00 p.m. through Sunday and statutory holidays.
- g. When a tie is broken by flipping a coin, points and money go to the decision of the flip. Judge is to make the flip.
- h. It is suggested that equipment not be set up until the arena is cleared to discourage the use of equipment for practicing.
- i. A second area may be arranged to run classes, if the regular ring is to be used for non-MWHS classes not requiring the MWHS Judge.

- j. All show committees wishing to hold a MWHS point award show must submit their applications and approval forms at least 60 days in advance of the date of the shows held by June 30th or at least 60 days in advance of the shows held after June 30th of the current year.

MWHS Rulebook section above revised 2003 & 2007

- k. If an application and approval form for show approval of a MWHS point award show is received after the deadline and the Board of Directors have duly met and decided it would benefit the Society to hold this show, all members must be adequately notified, either by MWHS Newsletter or by a separate flyer. The sponsoring show committee is responsible for the costs of producing and mailing the flyers to all MWHS members.
- l. After the show is approved, any change of a Judge must be reported to the Show and Contact chairperson and the Board of Directors must decide on approval before the start of the first class.
- m. There shall be no MWHS shows held after Thanksgiving weekend.
- n. Lightening Policy – The show needs to wait 20 minutes following the last bolt.

MWHS Rulebook section above revised 2011

3.10 ENTRIES

- a. A horse can only be entered once in each class at a show.
- b. A horse will not be allowed to compete unless proper entry has been made and both horse and rider have fulfilled all rules as required prior to the event.
- c. Entries close when the class begins.
- d. Horses 4 years and under are allowed to have one exhibition run per show per day at the end of the Senior barrel race (for which they may or may not be charged a time fee at the discretion of the show committee) provided that they have not entered any barrel race that day. No other timed events are allowed exhibition runs.
- e. Exhibition rides allotted are not point eligible or placed. MWHS encourages clubs to charge same fee as actual class and fee be included on class list.
- f. Only at MWHS sanctioned shows put on by MWHS will class entries be refunded if you scratch from you class.

3.11 CONDUCT

- a. All contestants must make a genuine effort in each class. In case of ties in speed events, reruns must be within 2 (two) seconds of time of last run.
- b. Horses must enter and leave the ring under control at all times unless otherwise advised by the Judge or Show Committee. This includes no running into the ring before the 10 foot (3 meter) pylons or markers. Riders must use discretion when riding on the show grounds.

MWHS Rulebook section above revised 2010 & 2014

- c. All horses entered in a class to be judged must assemble at the entrance of the arena in ample time for the judging to start promptly and to continue without delay and shall remain there (except while competing) until dismissed by the Judge or Ring Steward shall otherwise direct. Exhibitor will be allowed one minute at the Judges discretion from last call until starting performance in ring.
- d. Any request to speak to a Judge must go through the Ring Steward.
- e. Exhibitors may be disqualified for unsportsmanlike conduct and may be subject to further disciplinary actions for future functions.

MWHS Rulebook section above revised 2012

- f. Hands off Policy- No show staff or volunteers touch another person unless that person has asked for assistance. If the person is acting disrespectful, unsportsmanlike and the situation is escalating the police or security are to be called and if necessary the show will stop until the police or security have arrived and dealt with the situation.

MWHS Rulebook section above revised 2017

3.12 DISQUALIFICATIONS

- a. Rider cannot use ends of reins or flagstuffs. Excessive spurring or hitting the horse in or out of show ring could cause disqualification. No spurring the horse in front of the cinch. Overuse of spurs is up to the Judge, Ring Steward or Show Manager.
- b. Any rider interfering with, colliding with or cutting off other riders is to be disqualified.
- c. Exhibitors may not use the show's equipment in the ring at any time before their class is run.
- d. In all classes, any rider and/or horse which falls during performance is automatically disqualified. A rider falls when he/she has to vault or dismount in the ring. A horse has fallen when the shoulder or haunch touches the ground.
- e. When riding in any performance class, the rider cannot hold onto the saddle or horn with the free hand.
- f. Any contestant who is assisted by another person inside the arena or show ring will be disqualified.
- g. Failure to wear a number or the correct number in a visible manner will result in disqualification.

MWHS Rulebook revised 2002 & 2008

3.13 PERFORMANCE

- a. Any Junior horse 5 years old or under may be shown in a snaffle bit or bosal. Any pony regardless of age may be shown in a snaffle bit. Rider must ride with two hands in all performance classes if using a snaffle bit or bosal.
- b. Gait terminology: walk, extended walk, jog, extended job, lope, extended lope, trot, extended trot, canter and hand gallop to be used at the Judge's discretion.
- c. Patterns must be posted 1 hour before class for Adult, Junior A and Junior B showmanship classes and Adult, Junior A horsemanship classes.
- d. All youth classes must use the entire ring unless directed otherwise.
- e. In all rail classes, horses may not be pulled off the rail individually for placing.
- f. All youth 18 years and under as of January 1 must wear a helmet while mounted. .

MWHS Rulebook section above revised 2014,2022

3.14 TIMED EVENTS

- a. All distances must be measured with a tape measure when possible.
 - b. Courses must be set up in such a manner that horses have ample room to turn and stop, minimum of 40' (12.25 m) is recommended.
 - c. No obstacle may be less than 15' (4.5 m) from any rail and end barrel or pole must be no less than 20' (6 m) from the rail.
 - d. Whenever possible, starting poles are to be moved back to the fence. If not, they are to be a minimum of 25' (7.75 m) apart.
 - e. In all timed events, horses are to have a running start within the ring.
 - f. Timing shall begin when the horse's nose reaches the starting line and will be stopped when the horse's nose passes over the finish line.
 - g. If the timer fails during a qualifying run, the exhibitor can have two more chances to make a qualifying run.
 - h. Bats, crops and over and under ropes are allowed in Senior and Junior A timed events. In Junior B events – they can use crops and/or spurs only.
 - i. Horses are not to be released until they reach the markers. Markers are to be placed within a maximum of 10' (3 m) prior to the gate. Horses must leave the ring under control. Failure to do so may result in disqualification. Markers would consist of two pylons. Once horse is in the ring, gates are closed and will remain closed until the horse is ready to exit the ring.
- MWHS Rulebook section above revised 2003 & 2010
- j. Knocking over timing standards, barrels or markers constitutes disqualification except when knocking barrels or poles in Barrel Race or Polebending they will receive a 5 second penalty for each barrel or pole knocked over.
 - k. All rules apply to Open, Junior A and Junior B classes.

- l. Helmets must be worn by Junior B's in all riding classes including Leadline and Walk/Jog classes. Helmets are mandatory for all Youths in any speed event class.
- m. Either the Judge, Ring Steward or appointed official should be in a position to be consistently call any infractions.
- n. In the Keyhole event, the Judge must be in the ring and be in a position adjacent to the keyhole to be able to call any infractions.
- o. In the event that the timer fails, two stopwatches will be available to be used as the official time.
- p. Warm up Barrels, riders have 60 seconds from the time they enter the gate before they have to exit.

MWHS Rulebook section above revised 2018

3.15 HUMANE TREATMENT OF HORSES

No person on the show grounds may treat a horse in any inhumane manner which includes, but is not limited to:

- a. Placing an object in a horse's mouth to cause undue discomfort or distress.
- b. Tying a horse in a manner to cause undue discomfort or distress to any time, including lunging and riding.
- c. Use of inhumane training techniques or methods. For example: Poling – striking of horse's legs with objects (jumping poles, trail poles, etc.)
- d. Use of inhumane equipment.
- e. Any item or appliance that restricts movement or circulation in the tail.
- f. Upon report or discovery of inhumane treatment, the incident shall be investigated by the Board of Directors in conjunction with the show committee. The discipline or course of action will be determined by the Board of Directors.

MWHS Rulebook section above revised 2005

- g. Intentional or negligent treatment which results in any bleeding, for the purposes of this section, negligence is the failure to exercise care that a reasonably prudent person would exercise. Regardless of whether the bleeding resulted from intentional or negligent treatment the horse may be disqualified.

MWHS Rulebook section above revised 2016

h. Statement of principle on welfare of horses:

- Upholding the welfare of horses, regardless of value, as a primary consideration in all activities.
- Requiring that horses be treated with kindness, respect and the compassion that they deserve and that they never be subjected to mistreatment.
- Ensuring that the owners, trainers, exhibitors and their agents use responsible care in the handling, treatment and transportation of their horses as well as horses placed in their care for any purpose.
- Providing for the continuous well-being of horses by encouraging routine inspection and consultation with health care professionals and competition officials to achieve the highest possible standards of nutrition, health, sanitation and safety as a matter of standard operating procedure.
- Continuing to support scientific studies on equine health and welfare.
- Increasing education in training and horsemanship practices.
- Requiring owners, trainers and exhibitors to know and follow their sanction organizations rules and to work within the industry regulations in all equestrian competitions.
- Reviewing, revising and developing competition rules and regulations that protect the welfare of horses.

The standard by which conduct or treatment will be measured is that which a reasonable person, informed and experienced in generally accepted equine training and exhibition procedures would determine to be neither cruel, abusive nor inhumane.

MWHS Rulebook section above revised 2012

4.0 POINTS AND AWARDS

All Awards are to be embroidered, plated or engraved with the MWHS logo. Class/ Classes won and winner's name to also be included whenever possible

MWHS Rulebook section above revised 2022

1. a. A ten point sliding system will be used; awarding one point per entry shown up to ten horses, except Supreme Halter Horse and Reserve Supreme Halter Horse Champion. To earn this title, the first and second place of each age category in each sex division will compete together and the judge will choose a Supreme Champion and a Reserve Supreme Champion. The Supreme Champion will get 2 points more than the largest class and the Reserve champion will get 1 point more than the largest class. At the annual awards banquet there will be an overall Supreme Halter Horse Champion and a Reserve Supreme Halter Horse Champion.

MWHS Rulebook section above revised 2020

- b. Junior A pleasure will run as one class and points will split into 13 & under and 14-18 age divisions for year-end awards. Junior A barrels will run as one class with points split into both age divisions for year-end awards.
2. a. Points for year-end awards will count only if the horse's exhibitor is a member at the time the horse earns the points.
- b. Points to count for horse only except in Walk/Jog/Trot; Junior A, Junior B and Adult Showmanship; Adult Horsemanship and all Novice classes, which will count for horse and exhibitor combination. Lead Line class points count for rider only. If there is a death or injury of an exhibitor's horse, the exhibitor can apply to have their points changed over to their next horse but, will only be permitted one change per season. English Equitation – horse/rider judged class, not to be included in high point.
- c. Exhibitor/horse must compete in 50% (rounded down) of that class held during the year to be eligible for a year end award.
3. Year end individual class and overall ties will be broken by adding the next highest class(es) from shows dropped, highest to lowest and one at a time until tie is broken or extra class(es) are used up. If still tied, count greatest number of firsts, then seconds, etc. until tie is broken. If still tied, after that the tie will remain and both horses or exhibitors will be awarded. Halter ties will be broken.

MWHS Rulebook section above revised 2017

4. The classes that will be eligible for yearend awards will be determined by the Board of Directors and will be listed on the current year's show approval form.
5. a. 75% of all shows where a class was held count for individual class awards, the overall High Point division awards are calculated by adding up those totals from the 75% of shows where the class was held. In the case of 75% not being an even number, the higher number of shows will count.
- b. In Open. Performance and Speed Events at each show, only the exhibitor's top 5 classes count (excluding Junior Horse Western Pleasure) for Overall points when more than 5 classes are approved eligible for points. All classes still count for individual class awards.

MWHS Rulebook section above revised 2007,2022

6. In the case of a cancelled show, the classes that have run count for points for individual class awards only, but not for overall High Point awards, unless the entire division has been run.
7. All approved Halter classes will be eligible for individual class awards. Overall High Point awards will be given to the High Point Mare, High Point Gelding and High Point Stallion.
8. Grand and Reserve Grand points count for individual class awards and overall High Point awards.
9. All Junior A and B approved classes that are held at least 50% of the 75% of shows during the year will be eligible for individual class awards. All approved classes will count towards the High Point Open. Performance and High Point Open, Speed Events awards in Junior A and B divisions. Each Horse & Rider combination must compete in at least two (2) different classes in each division to be eligible for High Point awards

MWHS Rulebook section above revised 2017, 2022

10. When more than 5 classes have been approved to be eligible for points, only the top 5 Open. Performance and Speed Events approved classes held during that year will receive individual class awards. All approved Open Performance classes with the exception of: Adult Showmanship, Adult Horsemanship, Sr. English Equitation, Junior Horse Western Pleasure and Novice classes will count towards the High Point Performance award. All approved Open Speed Event classes with the exception of Novice will count toward the High Point Speed Events award. In order to qualify for the rotating High Point Open Performance award, a horse must compete in 3 different approved Open Performance classes during the current year. To qualify for the High Point Open Speed Event award a speed horse must compete in at least 3 different Open Speed event classes during the current year. To qualify for individual event High Point Horse award the following classes are used to calculate the winner: Open Western Pleasure, Open English Pleasure, Trail, Open Barrels, Open Polebending and Open Keyhole (3 performance, 3 speed).

MWHS Rulebook section above revised 2012, 2013, 2014, 2022

11. Overall Novice awards will consist of the 3 following divisions: High Point Halter, High Point Performance and High Point Speed Events. Points may be accumulated in Novice as well as other approved Halter and Sr. classes. For High Point Novice, Performance and Speed awards the exhibitor/horse must qualify in a minimum of 2 classes for the year in order to be eligible to receive the award. Exhibitors may show in up to 40 performance and 40 speed event shows in total. It will be up to the committee to decide whether exhibitors graduates.

12. All Junior B exhibitors that compete in 50% (rounded down) of a class and not receiving a year end award will receive a participant award. This includes Leadline and Walk/Jog classes.

13. Points will be available for inspection at all Director's meeting.

MWHS Rulebook section above revised 2007

4.1 APPROVED CLASSES

<u>HALTER</u>	2 and under Stallions, 2 and under Geldings, 2 and under Mares 3 and over Stallions, 3 and over Geldings, 3 and over Mares	
<u>YEARLING LUNGE LINE</u>	Optional – (starts Civic Holiday Weekend)	
<u>LEAD LINE</u>	Mandatory (7 years and under)	
<u>JUNIOR B</u>	<u>Performance (3)</u> Showmanship at Halter Equitation (English or Western attire) Western Pleasure Trail Walk/Jog/Trot on a Pony (optional) Walk/Jog/Trot on a Horse (1)	<u>Speed Events (3)</u> Cloverleaf Barrel Race Keyhole Polebending Down & Back
<u>JUNIOR A</u>	<u>Performance (3)</u> Showmanship at Halter English Pleasure Western Pleasure Western Horsemanship	<u>Speed Events (3)</u> Cloverleaf Barrel Race Keyhole Polebending Flag Race
<u>Open</u>	<u>Performance (all)</u> Trail English Pleasure Western Pleasure Reining Ranch Western Pleasure/Ranch Riding Jr. Horse Western Pleasure Jr. Horse English Pleasure English Equitation Walk/Jog/Trot on a Horse (Rider 13+)	<u>Speed Events (all)</u> Cloverleaf Barrel Race Keyhole Polebending Flag Race Down & Back
Optional Ranch Rail		
<u>NOVICE (Optional)</u>	<u>Performance</u> Showmanship (Mandatory) Trail <u>Western Pleasure</u>	<u>Speed Event</u> Cloverleaf Barrel Race Polebending Flag Race
<u>ADULT (1)</u>	<u>Performance</u> Adult Showmanship Adult Horsemanship	
<u>NON POINT</u>	<u>Performance</u> Western Riding	<u>Speed Event</u> Texas Speed & Action Combination

NOTE: Mandatory classes (number required shown in brackets) are listed on show approval application from.

MWHS Rulebook section above revised 2004, 2008, 2011, 2014, 2017, 2019, [2022](#)

5.0 HALTER CLASSES

All halter classes are required at shows where halter classes are held. Order of classes will be: Stallions, Geldings and Mares. The list of classes is on the previous page.

The Judge will examine each horse individually and check the action of all horses as they are brought into the ring. Confirmation and soundness will be considered to determine the places in each class.

Whips may not be used in halter.

Junior exhibitors are not allowed to show in any of the Stallion classes.

When judging of all classes in a halter sex division has been completed, the first and second place of each age category in each sex division will compete together and the judge will choose a Supreme Champion and a Reserve Supreme Champion. The Supreme Champion will get 2 points more than the largest class and reserve supreme champion will get 1 point more than the largest class. At the annual awards banquet there will be an overall Supreme Halter Horse Champion and a Reserve Supreme Halter Horse Champion.

MWHS Rulebook section above revised 2020

6.0 YEARLING LUNGE LINE (Optional)

It is mandatory that the Yearling Lunge Line class not be held prior to July 1st. A 2 year old class may be held up to June 30. The Yearling Lunge Line class was developed to give breeders and owners of pretty moving, performance oriented yearlings, an opportunity to show them as performance prospects. The Lunge Line class is considered a performance event and the class is to be judged on way of going and attitude.

Even though appropriate levels of training will be recognized, these horses are not expected to demonstrate behavior or performance beyond that necessary for a reasonable presentation to the judge. It is suggested that all yearling lunge line classes be held in one go format only.

Horses are to be shown in a halter, regular or show type is acceptable. For the lunging demonstration, the only attachment allowed to the halter is the lunge line. The lunge line may not exceed 30' (9m) in length with a chain or snap attached to the halter. The lunge line must hang free from the halter without touching any part of the horse. It is permissible to use a lunge whip. No other equipment is allowed on the horse during the class. Mechanical or retractable lunge lines are not allowed. Conventional western attire is mandatory except if the prospect is considered to be hunt seat then conventional English attire is optional.

Judge(s) will stand outside the lunging circle. The exhibitor will enter the arena and await the start whistle. When the whistle is blown, the exhibitor will be allowed 1 ½ (one & a half) minutes to present their horse. At the end of the 1 ½ minutes the whistle will blow again to signify the end of the run. Show management has the option of adding a "half way" whistle if they choose.

The horse will be scored at the walk, jog or long trot, and lope or canter in both directions. Any horse that does not exhibit these gaits in each direction will be disqualified from the class. The exhibitor may begin work in the direction of their choice (clockwise or counter clockwise).

At the end of 1 ½ minutes, the whistle will be blown and the exhibitor shall, at the request of show management either:

- A) Retire from the lunging area and retire to the far end of the ring or
- B) Leave the ring and wait nearby to return for the conformation judging.

If the horses remain in the ring, they are to stand quietly on the rail while the other exhibitors are being judged.

If the horse's nose, mouth or jaw areas show signs of broken skin, rawness or bleeding, the horse will be eliminated from competition.

If the horse is playing on the lunge line, it shall not count against the horse. The horse should be judge as though the pleasure prospect was playing in the field. The Judge may at his/her discretion, penalize the horse for excessive bucking, running off or displaying attitudes that are uncomplimentary to pleasure horses such as excessive ear pinning or tail wringing.

Exhibitors are encouraged to exhibit their horses making full use of a 20' (6m) radius circle as they will be scored on this.

After lunging competition is complete, the horses will line up halter fashion in their order of go and prepare for final conformation judging. The judges may not discriminate against bulk, but rather look for a total picture, emphasizing balance and athletic capability and should use this opportunity to review their preliminary score.

For conformation judging, the exhibitor may change over to the lead shank in place of the lunge line. The lead shank or lunge line chain may only be used under the chin, over the nose or hanging from the halter. **An exhibitor may show a maximum of 3 horses in each yearling lunge line class.**

If a prospect is considered to be hunt seat prospect, then it shall be braided and shown at the walk, long trot and canter.

A lunge line scoring sheet must be used for each lunge line class. Use of a scribe is recommended. Maximum total score is 70 with 34 being average. The judge will have sole discretion to use their own personal preference when breaking any ties in total points.

7.0 LEAD LINE

Exhibitor must be 7 years of age or under as of January 1st of the current year and may not enter any other riding class.

Rider must have a MWHS membership to accumulate points.

Handler must be 14 years of age or over as of January 1st of the current year. Handler does not need a MWHS membership for rider to accumulate points.

Horse or pony and English or Western tack are permissible. One hand is to be used when riding with a curb bit, two hands are to be used with a snaffle bit or bosal regardless of the age of the horse.

Rider must be properly attired and handler must be dressed accordingly. Riders must wear protective head gear and his or her feet in the stirrups and the stirrups be securely attached to the saddle with buddy stirrups being acceptable

MWHS Rulebook section above revised 2016, 2017

No Stallions allowed.

A shank of at least 6' (2m) must be attached to the halter, over or under the headstall or bosal, so that the horse is controlled at all times.

Entries must enter the ring at a walk and will walk only both ways of the ring. They may be asked to back up in the lineup and should do so without the aid of the handler.

Rider will be judged on their basic position in the saddle, hands, seat and back position. Rider's neatness and suitability to count in determining their placing.

Points to count for rider only.

An office fee will be charged for lead liners.

8.0 PERFORMANCE CLASSES

Refer to General Rule 3.13

Junior Horse Western Pleasure Rule 8.3

8.1 ADULT SHOWMANSHIP

Exhibitor must be 19 years and over as of January 1st for the current year.

Pattern to be decided at the discretion of the Judge and posted one hour prior to the class.

Only the exhibitor is to be judged. The horse is merely a prop to show the ability of the showmanship. Showmanship at halter shall be a separate class from the other halter classes. This class is to be judged strictly on the exhibitor's ability to fit and show a horse.

MWHS Rulebook section above revised 2004

Horse should be in good condition, hair coat clean, well brushed, mane and tail clean, free of tangles and hooves properly trimmed. Tack should be neat, clean and in good repair. Exhibitor should be in suitable western attire. Clothes and exhibitor to be neat and clean.

Judge may ask rider questions on tack, equipment, equitation and simple anatomy.

8.2 ADULT HORSEMANSHIP

Exhibitor must be 19 years and over as of January 1st of the current year.

For Junior Horse Western Pleasure horses refer to Rule 8.3

Pattern to be decided at the discretion of the Judge and posted one hour prior to the class. Rail work is NOT mandatory.

Horses may be asked to walk, jog or lope one way of the ring at the Judge's discretion. Rider should sit to the jog, not post. At the lope the rider should be close to the saddle. The Judge may ask the rider questions on tack, equipment, equitation and simple anatomy. Exhibitors will be asked to stay in the ring if rail work will be asked.

The rider is to be judged on seat, hands, appointments of the horse and rider, suitability of horse and rider and the performance of the horse. Results as shown by the performance of the horse are not to be considered more important than the method used to obtain them.

MWHS Rulebook section above revised 2019

8.3 WESTERN PLEASURE

A good pleasure horse has a free-flowing stride of reasonable length in keeping with the confirmation. He should cover a reasonable amount of ground with little effort. Ideally, he should have a balanced, flowing motion while exhibiting correct gaits that are of the proper cadence. The quality of the movement and the consistency of the gaits are a major consideration. He should carry his head and neck in a relaxed, natural position with his poll level or slightly above the level of the withers. He should not carry his head behind the vertical, giving the appearance of intimidation or be excessively nosed out giving a resistant appearance. His head should be level with his nose slightly in front of the vertical having a bright expression with his ears alert. He should be shown on a reasonable loose rein, but with light contact and control. He should be responsive, yet smooth in transitions when called for. When asked to extend, he should move out with the same flowing motion. Maximum credit should be given to the flowing, balanced and willing horse that gives the appearance of being fit and a pleasure to ride. This class will be judged on the performance, condition and conformation of the horse.

Horses 6 years old and older must be shown in a curb bit.

Horses 5 years old and younger may be shown in either curb bit, hackamore or snaffle bit. If riding with two hands, reins must be crossed with the tails of the reins on the opposite side of the neck. The rider's hands should be carried near the pommel and no further than four inches (10 cm) out on either side of the saddle horn. Rider's hands must be steady with very limited movement.

Reins are to be held in one hand with no more than one finger between them and not changed during the performance except for Jr. horses using a snaffle bit or bosal.

Horses to be shown at a walk, jog and lope on a reasonable loose rein or light contact without undue restraint.

Judge may ask for added performance suitable to a pleasure horse for any gaits to be extended, except that only the top twelve horses may be asked to extend the lope. A moderate extension of the jog is a definite two-beat lengthening of stride, covering more ground. Cadenced and balanced with smoothness is more essential than speed.

Horses are required to back, but Judge may ask only the finalists to back, at his/her discretion.

Horses are to be reversed to the inside (away from the rail). They may be required to reverse at the walk or jog at the discretion of the judge, but shall not be asked to reverse at the lope.

Rider shall not be asked to dismount except in the event the judge wishes to check equipment.

MWHS Rulebook section above revised 1998 & 2015

In all rail classes, horses may not be pulled on the rail individually for placing.

Horse shall also be penalized for excessive speed or slowness, incorrect lead, breaking gait, opening mouth excessively, stumbling or falling, unfitness or choppy stride.

Disqualifications:

- Changing hands of two hands on reins, except when using a snaffle bit or bosal.
- More than one finger between reins.
- Head carried so low that tip of ear is below the withers for more than five strides.
- Nose is carried behind the vertical for more than five strides.

Performance - 60 pts.

Condition & Conformation – 10 pts.

Manners – 20 pts.

Neatness of horse & rider – 10 pts.

8.4 TRAIL

This class will be judged on the performance of the horse over obstacles, with emphasis on manners, response to the rider and a quality of movement. This is a "Show Horse" trail class and is not an Extreme Trail or Trail Challenge class. Some obstacles used in Extreme Trail or Trail Challenge are not acceptable for this class.

MWHS Rulebook section above revised 2012

- a. Credit will be given to horses negotiating the obstacles with style and some degree of speed, providing correctness is not sacrificed. Horses should receive credit for showing attentiveness to the obstacles and the capability of picking their own way through the course when obstacles warrant it and are willing to respond to rider's cues on more difficult obstacles.
- b. Horses shall be penalized for any unnecessary delay while approaching or negotiating the obstacles. Horses with artificial appearance over obstacles should be penalized.
- c. Except for Junior horses shown with in a snaffle bit or bosal, only one hand may be used on the reins, except that it is permissible to change hands to work an obstacle. While the horse is in motion, rider's hands shall be clear of the horse and saddle.
- d. Horses must not be required to work the rail. The course must be designed, however, to require each horse to show the three gaits (walk, jog & lope) somewhere between obstacles as part of its work and quality of movement and cadence should be considered as part of the maneuver score. While on the line of travel between obstacles, the horse shall be balanced, carrying his head and neck in a relaxed and natural position with the poll level or slightly above the withers. The head should not be carried behind the vertical, giving the appearance of intimidation or be excessively nosed out giving a resistant appearance. Gait between obstacles shall be at the discretion of the judge.
- e. The course must be posted at least one hour before the class begins.
- f. Scoring will be on the basis of 0 – infinity, with 70 denoting an average performance. Each obstacle will receive an obstacle score that should be added or subtracted from 70 and is subject to a penalty that should be subtracted. Obstacle scores are as follows: +1 ½ Excellent, +1 Very Good, +1/2 Good, 0 Correct, -1/2 Poor, -1 Very Poor, -1 ½ Extremely Poor. Obstacle scores are to be determined and assessed independently of penalty points.
- g. Penalties are to be assessed per occurrence as follows:

<u>Penalty ½</u>	For each tick or contact of a log, pole, cone, plant or any component of an obstacle
<u>Penalty 1</u>	For each hit, bite or stepping on a log, cone, plant or any component of the obstacle Incorrect or break of gait at the walk or jog for two strides or less Both front feet or hind feet in a single stride slot or space at the walk or jog Skipping over or failing to step into required space Split pole in lope over Incorrect number of strides, if specified
<u>Penalty 3</u>	For incorrect or break of gait a walk or jog for more than two strides Out of lead or break of gait at lope (except when correcting and incorrect lead) Knocking down an elevated pole, cone, plant, barrel, obstacle or severely disturbing an obstacle Missing or evading pole that is a part of an obstacle or part of a series of an obstacle with one foot.
<u>Penalty 5</u>	For dropping slicker or object required to be carried on course. First or second cumulative refusal, balk or evading an obstacle by shying or backing Letting go or dropping the gate Use of either hand in instilling fear or praise Falling or jumping off or out of the bridge or water box with more than one foot once the horse has gotten onto or into the obstacle Stepping outside the confines of an obstacle with designated boundaries (i.e. back through, 360 degree box, side pass) with more than one foot once the horse has entered the obstacle Missing or evading a pole that is part of a series of an obstacle with more than one foot

Blatant disobedience (including kicking out, bucking, rearing, striking)
Holding the saddle with either hand

Disqualified 0 Score:

- Use of two hands or changing hands on the reins: except for Jr. Horses shown with a bosal or snaffle bit, only one hand may be used on the reins, except it is permissible to change hands to work an obstacle or to straighten reins when stopped.
- Use of romal reins other than specified
- Performing the obstacle incorrectly or other than in specified order
- No attempt to perform an obstacle
- Equipment failure that delays completion of pattern
- Excessively or repeatedly touching the horse on the neck to lower head
- Entering or exiting an obstacle from the incorrect side or direction
- Working obstacle in the incorrect direction: including overturns of more than ½ turn
- Riding outside designated boundary marker of the arena or course area
- Third cumulative refusal, balk or evading an obstacle by shying or backing
- Failure to ever demonstrate correct lead and/or gait as designated
- Failure to open and shut gate or failure to complete gate.

Faults scored according to severity which occur on the line of travel between obstacles include:

- Head carried too low (tip of ear below the withers consistently)
- Over flexing or straining neck in head carriage so the nose is carried behind the vertical consistently.

- h. Management, when setting course, should keep in mind that the idea is not to trap a horse or eliminate it by making an obstacle too difficult. All courses and obstacles are to be constructed with safety in mind so as to eliminate any accidents. When distances and spaces are measured between all obstacles, the inside base to inside base measurement of each obstacle considering the normal path of the horse should be the measuring point. Enough space must be provided for a horse to jog (at least 30 feet or 9 meters) and lope (at least 50 feet or 15 meters) for the judge to be able to evaluate these gaits.
- i. If disrupted, the course shall be reset after each horse has worked. In the case where combinations of obstacles are to be used the course cannot be reset until the contestant finishes the entire course, regardless of where the disruption occurred.
- j. At least six obstacles must be used, three of which must be from the mandatory list of obstacles and at least three different others selected from the list of optional obstacles.

k. **Mandatory Obstacles:**

1. Opening, passing through and closing gate: (Losing control of the gate is to be penalized). Use of gate which will not endanger horse or rider. If the gate has a metal, plastic or wood support bar under the opening, contestants must work the gate moving forward through it.
2. Ride over a least four logs or poles: These can be a straight line, curved, zigzag or raised. The space between logs is to be measured (inside base to base) and the path the horse is to take should be the measuring point. All elevated elements should be placed in a cup, notched block or otherwise secured so they cannot easily roll. The height should be measured from the ground to the top of the element. Spacing for walkovers should be 20 inches or 24 inches (50 cm to 60 cm) and may be elevated to 12 inches (30 cm). Elevated walkovers should be set at a minimum of 22 inches (55 cm) apart. The spacing for trot overs should be 3 feet to 3 feet 3 inches (90 cm to 100 cm). If elevated, they may be elevated to a maximum of 8 inches (20 cm). The spacing for lope overs can be 6 feet to 6 feet 6 inches (1.8 meters to 2 meters) or increments there of any can be elevated to a maximum of 8 inches (20 cm).

3. Backing obstacle: Backing obstacles to be spaced a minimum of 28 inches (70 cm) or 30 inches (75 cm) if elevated. Exhibitors cannot be asked to back over a stationary object such as metal bar or wooden pole.
 - A) Back through and around at least three markers.
 - B) Back through L, U, V, straight or similar shaped course. Element can be elevated no more than 24 inches (60 cm).

MWHS Rulebook section above revised 2012

l. Optional Obstacles:

1. Water hazard (ditch or small pond). No metal or slick bottomed boxes will be used.
2. Serpentine obstacles at a walk or jog. The spacing is to be a minimum of 6 feet (1.8 meters) for the jog.
3. Carry object from one part of the arena to another. Only objects which might be expected to be carried on a trail ride may be used.
4. Ride over wooden bridge. Suggested minimum width shall be 36 inches (90 cm) and at least 6 feet (2 meters) long. Bridge should be sturdy, safe and negotiated at a walk only.
5. Put on and remove a slicker.
6. Remove and replace materials from a mailbox.
7. Side pass (may be elevated to 12 inches (30 cm) maximum).
8. An obstacle consisting of four logs or rails, laid in a square, minimum width of the square should be 6 feet (1.8 meters). Each contestant will enter the square by riding over a log or rail as designated. When all four feet are inside the square the rider should execute a turn as indicated and depart out over trail or log as designated.

MWHS Rulebook section above revised 2012 & 2015

m. Optional Obstacles:

1. Any other safe and negotiable obstacle which could be encountered on a trail ride and meets the approval of the judge may be used.
2. A combination of two or more obstacles is acceptable.

n. Unacceptable Obstacles:

1. Tires
2. Animals
3. Hides
4. PVC pipe
5. Dismounting
6. Jumps
7. Rocking or moving bridges
8. Water box with floating or moving parts
9. Flames, dry ice, fire extinguishers, etc.
10. Logs or poles elevated in a manner that permits such to roll
11. Ground ties
12. Tents or tarps
13. Umbrellas, shower curtains, pool noodles or similar items

MWHS Rulebook section above revised 2012 & 2015

- o.** The judge must walk the course and has the right and duty to alter the course in any manner. The judge may remove or change any obstacle he deems unsafe or non-negotiable. If at any time, a trail obstacle is deemed to be unsafe by the judge, it shall be repaired or removed from the course. If it cannot be repaired and horses have completed the course, the score for the obstacle shall be deducted from all previous works for that class.

MWHS Rulebook section above revised 2012

- p. A standard scoring sheet will be used for all trail classes at the MWHS approved show to be completed by the Judge and audited, then posted for a maximum of thirty minutes before placings will be announced (scoring sheet similar to AQHA score sheet supplied by MWHS).
- q. The course designer shall design the trail class to not trap the horses. Trail courses are to be set so the experienced horses can show their skills, the middle horses are challenged, the novice horses and riders are able to try and negotiate the course. Practical spacing between obstacles should be considered when setting up the course. Length between obstacles for walk, jogs and lopes are established.

MWHS Rulebook section above revised 2003



MWHS TRAIL SCORE SHEET

JUDGE
CLASS
DATE

TRAIL OBSTACLE SCORES

+1 ½ - Excellent; +1 - Very Good; +1/2 - Good; 0 - Correct; -1/2 - Poor; -1 - Very Poor; -1 ½ - Extremely Poor

PENALTY ½:

Each tick or contact of a log, pole, cone, plant or any component of an obstacle

PENALTY 1: Hit, bite or stepping on log, cone, plant or any component of the obstacle;

Incorrect or break of gait at walk or jog for 2 strides or less;

Both front or hind feet in a single strided slot or space at the walk or jog;

Skipping over or failing to step into required space; Split pole in lope over

Failure to meet the correct strides on trot over & lope over log, if specified

Stepping outside the confines of an obstacle with designated boundaries with one foot once the horse has entered the obstacle

Missing or evading a pole that is part of a series of an obstacle with one foot.

PENALTY 3:

Incorrect or break of gait at walk or jog for more than 2 strides;

Out of lead or break of gait at lope (except when correcting an incorrect lead);

Knocking down an elevated pole, cone, plant, barrel or severely disturbing an obstacle;

Falling or jumping off or out of a bridge or water box with 1 foot once the horse has got onto or into that obstacle;

Stepping outside the confines of an obstacle with designated boundaries with one foot once the horse has entered the obstacle;

Missing or evading a pole that is part of a series of an obstacle with one foot.

PENALTY 5:

Dropping slicker or object required to be carried on course; 1st refusal or 2nd cumulative refusal, balk or evading of object by shying or backing;

Letting go of gate or dropping rope gate;

Use of either hand to instill fear or praise;

Falling or jumping off or out of a bridge or water box with more than 1 foot once the horse has got onto or into that obstacle;

Stepping outside of confines of an obstacle with designated boundaries with more than one foot once the horse has entered the obstacle;

Missing or evading a pole that is part of a series of an obstacle with more than one foot;

Blatant disobedience;

Holding saddle

PENALTY SCORE 0:

Use of 2 hands or changing hands on reins except for Jr. horses shown with hackamore or snaffle bit. Only one hand may be used on the reins, except that it is permissible to

change hands to work an obstacle, or straighten reins when stopped.

Use of romal other than outlined;

Performing obstacles incorrectly or other than specified order;

No attempt to perform obstacle;

Equipment failure that delays completion of pattern;

Excessively or repeatedly touching the horse on the neck to lower the head;

Entering or exiting an obstacle from the incorrect side or direction;

Working an obstacle the incorrect direction, including over turns of more than 1/4 turn;

Riding outside designated boundary marker of the arena or course area;

3rd cumulative refusal, balk or evading by shying or backing;

Failure to demonstrate correct lead or gait on line travel;

Failure to follow the correct line of travel within or between obstacles;

Use of more than 1 finger between reins;

Excessive schooling, pulling, turning, stepping or backing anywhere on course;

Failure to open and shut gate or failure to complete gate

DISQUALIFICATION SCORE 0:

Fall to ground;

On line of travel, head consistently carried too low (tip of ears below withers).

OBSTACLE SCORES: -1/2 Extremely Poor, -1 Very Poor, -1/2 Poor, 0 Correct, +1/2 Good, +1 Very Good, +1 1/2 Excellent

ENTRY NUMBER	OBSTACLE DESCRIPTION	1	2	3	4	5	6	7	8	9	10	11	12	PENALTY TOTAL	FINAL SCORE
	PENALTY														
	OBSTACLE SCORE														
	PENALTY														
	OBSTACLE SCORE														
	PENALTY														
	OBSTACLE SCORE														
	PENALTY														
	OBSTACLE SCORE														

JUDGES SIGNATURE _____

SAMPLE TRAIL PATTERN

1. Walk to and work gate.
2. Jog through cones.
3. Lope right lead to poles
4. Jog over poles into chute.
5. Back the L.
6. Lope left lead over poles.
7. Side pass left over poles.
8. Walk over the bridge, poles and into box
9. Perform a 360° turn to the right, walk out of box and over poles to finish

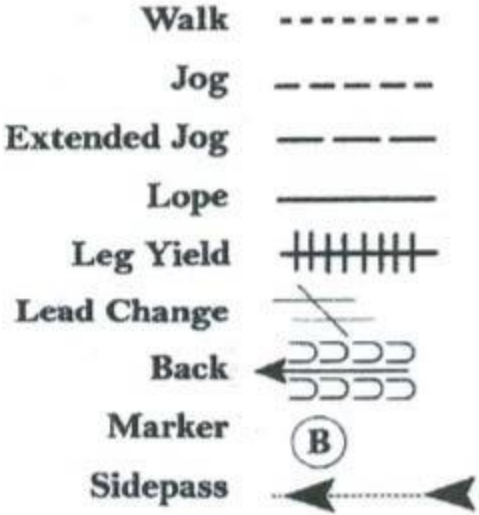

SAMPLE TRAIL PATTERN WITH MEASUREMENTS

*Recommend back through
30 - 40 in. (76 - 102 cm) apart.

*Recommend serpentine
8 - 10 ft. (244 - 305 cm) apart

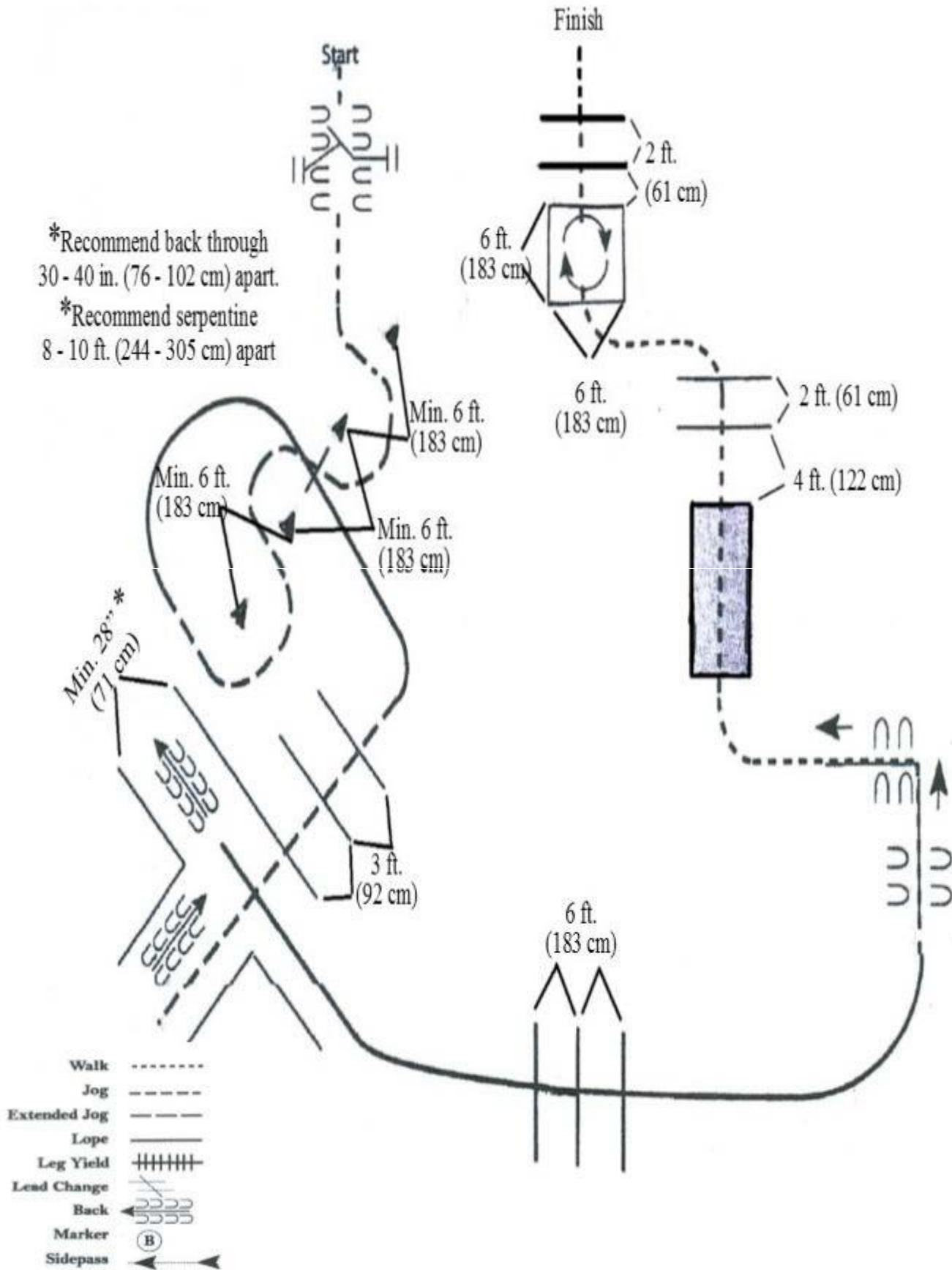

8.5 ENGLISH PLEASURE

Horse to be shown at a walk, trot and canter both ways of the ring. Horses are required to back, but Judge may ask only the finalists to back, at his discretion. Emphasis will be placed on suitability of purpose.

The Judge may require an exhibitor to extend any gait.

Horses may turn in either direction. They may be asked to reverse at the walk or trot, but not the canter.

In all rail classes, horses may not be pulled off the rail individually for placing.

Horses are to back easily and stand quietly.

Light contact with the mouth is recommended. The top eight horses may be required to gallop collectively. At the hand gallop, the Judge may ask the group to 'halt' and stand quietly on a loose rein.

Walk: True flat footed for pleasure classes.

Trot: Brisk, smart, cadenced and balanced without loss of form. Smoothness more essential than extreme speed, which will be penalized.

Canter: Smooth, collected and straight on both leads with the ability to push on if required to hand gallop.

Hand Gallop: Brisk with the horse under control, after which horses will be asked back to a standard canter.

Personal Appointments (required): see 3.4(b) ATTIRE

Tack Appointments (required): see 3.3(f) BITS Saddle must be hunting or forward seat, with or without suede. Saddle seat tack and apparel allowed.

Optional Appointments: Un-roweled spurs, crops, bats, gloves, English breast plate and braiding of mane and tail in hunt seat style.

Prohibited Appointments: Draw reins, martingales, boots of any type on the horse. Artificial appliances or western saddles may not be used.

MWHS Rulebook revised for above section 2001

8.5.1 ENGLISH EQUITATION

Rider should have a workmanlike appearance, seat and hands light and supple, conveying the impression of complete control should any emergency arise.

Method of holding the reins is optional and bight of reins may fall on either side. However, all reins must be picked up at the same time. All appointments are the same as in English Pleasure (explained later)

MWHS Rulebook revised for above section 2014

8.7 WESTERN RIDING

- a. Western Riding is an event where the horse is judged on quality of gaits, lead changes at the lope, response to the rider, manners and disposition. The horse should perform with reasonable speed and be sensible, well mannered, free and easy moving.
- b. Credit shall be given for the emphasis placed on smoothness, even cadence of gaits (i.e. starting and finishing pattern with the same cadence), and the horse's ability to change leads precisely, easily and simultaneously both hind and front at the center point between markers. In order to have balance, with quality lead changes, the horse's head and neck should be in a relaxed, natural position, with his poll level with or slightly above the level of the withers. He should not carry his head behind the vertical, giving the appearance of intimidation, or be excessively nosed out, giving a resistant appearance. The horse should have a relaxed head carriage showing response to the rider's hands, with a moderate flexion at the poll. Horses may be ridden with light contact or on reasonable loose rein. The horse should cross the log both at the jog and the lope without breaking gait or changing stride.
- c. The Judge shall select one of the three patterns to be performed. The Judge is responsible for the pattern being correctly set up and measured.

8.7 WESTERN RIDING

d. On the pattern:

1. The small circles represent pylon markers which are recommended. These should be separated by a uniform measured distance of not less than 30 feet (9 m) nor more than 50 feet (15 m) on the sides with 5 markers (see diagram). In pattern 1, the three markers on the opposite side should be set adjacent to the appropriate markers. It is recommended that markers be set on a minimum of 15 feet (4-1/2 m) from the fence and with 50 to 80 feet (15-25 m) width in the pattern, as the arena permits.
2. A solid log of pole should be used and be a minimum of 8 feet (2.5 m) in length.
3. The long serpentine line indicates the direction of travel and gaits at which the horse is to move. The shaded area represents the lead changing area between the markers. The recommended lead changing point is equal to 1/2 stride length before or after the center point between markers. The dotted line (...) indicates walk, the dashed line (- - -) indicates jog and the solid line (_____) lope.
4. A cone shall be placed along the wall or rail of the arena to designate where the exhibitor should initiate the walk. On pattern 1, the cone should be placed a minimum of 15 feet before the first pylon. On patterns 2, 3, 4 and 5, the cone should be placed even with the start cone. The on-deck exhibitor should not go to the start cone until the contestant on pattern has cleared the working area by the start cone for the final time.

MWHS Rulebook revised for above section 2001, 2015

e. Scoring will be on a basis of 0-100 with 70 denoting an average performance.

Points will be added or subtracted from the maneuvers on the following basis, ranging from plus 1 ½ to minus 1 ½:
-1.5 extremely poor, -1 very poor, -.5 poor, 0 average, +.5 good, +1 very good, +1.5 excellent

Maneuver scores are to be determined independently of penalty points.

f. A contestant shall be penalized each time the following occur:

One Half (1/2) point: Tick or light touch of log

One (1) point: Out of lead more than one stride either side of the center point and between the markers

Splitting the log (log between the two front or two hind feet) at the lope

Hind legs skipping or coming together during lead change

Break of gait at the walk or jog up to two strides

Non-simultaneous lead change (front to hind or hind to front)

Three (3) points: Not performing the specific gait (jog or lope) or not stopping when called for in the pattern, within 10 feet (3 m) of the designated area.

Simple change of lead

Out of lead at or before the marker prior to the designated area or out of lead at or after the marker after the designated change area

Additional lead changes any where in the pattern (except when correcting an extra change or incorrect lead)

In pattern 1 and 3, failure to start the lope within 30 feet (9 m) after crossing the log at the jog

Break of gait at the walk or jog for more than two strides

Break of gait at the lope

Five (5) points: Out of lead beyond the next designated change area (note: failures to change, including cross-cantering. Two consecutive failures to change would result in two, five point penalties)

Blatant disobedience including kicking out, biting, bucking and rearing

Holding the saddle with either hand

Use of either hand to instill fear of praise

MWHS Rulebook revised for above section 2001, 2015

Disqualified – Score 0: Illegal equipment

- Willful abuse
- Off course
- Knocking over markers
- Completely missing log
- Major refusal- stop and back more than two strides or four steps with front legs
- Major disobedience or schooling
- Failure to start lope prior to end cone in pattern #1
- Four or more simple lead changes and/or failures to change leads
- Failure to start lope within 30 feet of designated area in patterns 2, 3, 4, 5
- Overturn of more than 1/4 turn

Faults scored according to severity, which will be caused for disqualification include:

- Head carried too low and/or clearly behind the vertical excessively and consistently while the horse is in motion, or otherwise showing the appearance of intimidation (tip of ear below withers consistently)

Credits: Changes of leads, hind and front simultaneously

- Change of leads near the center point of the lead change area
- Accurate and smooth pattern
- Even pace throughout
- Easy to guide and control with rein and leg
- Conformation and fitness

g. The following characteristics are considered faults and should be judged accordingly in maneuver scores

- Opening mouth excessively
- Anticipating signals
- Stumbling
- Head carried too high
- Head carried too low (tip of ear below the withers)
- Over flexing or straining neck in head carriage so the nose is carried behind the vertical
- Excessive nosing out

MWHS 2015

Location Penalties for Designated Change

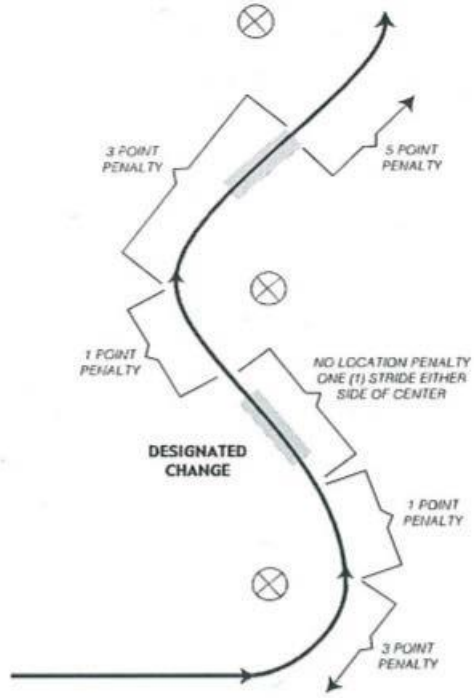

LEAD CHANGING AREA

Location Penalties for Designated Change

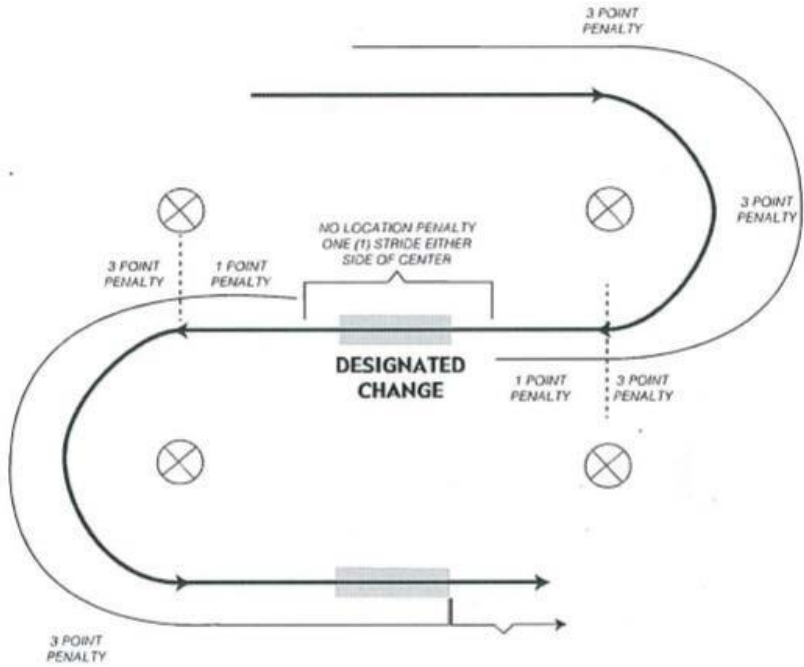

LEAD CHANGING AREA

WESTERN RIDING- PATTERN 1

1. Walk at least 15' from start cone to the first marker. Start jogging and jog over log.
2. Transition to left lead & lope around end.
3. First line change.
4. Second line change.
5. Third line change.
6. Fourth line change lope around the end of arena.
7. First crossing change.
8. Second crossing change.
9. Lope over log.
10. Third crossing change.
11. Fourth crossing change.
12. Lope up the center, stop & back

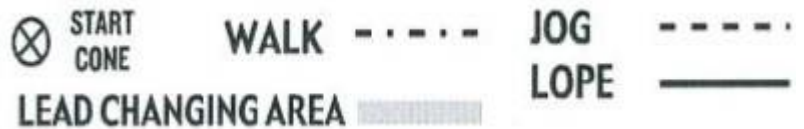
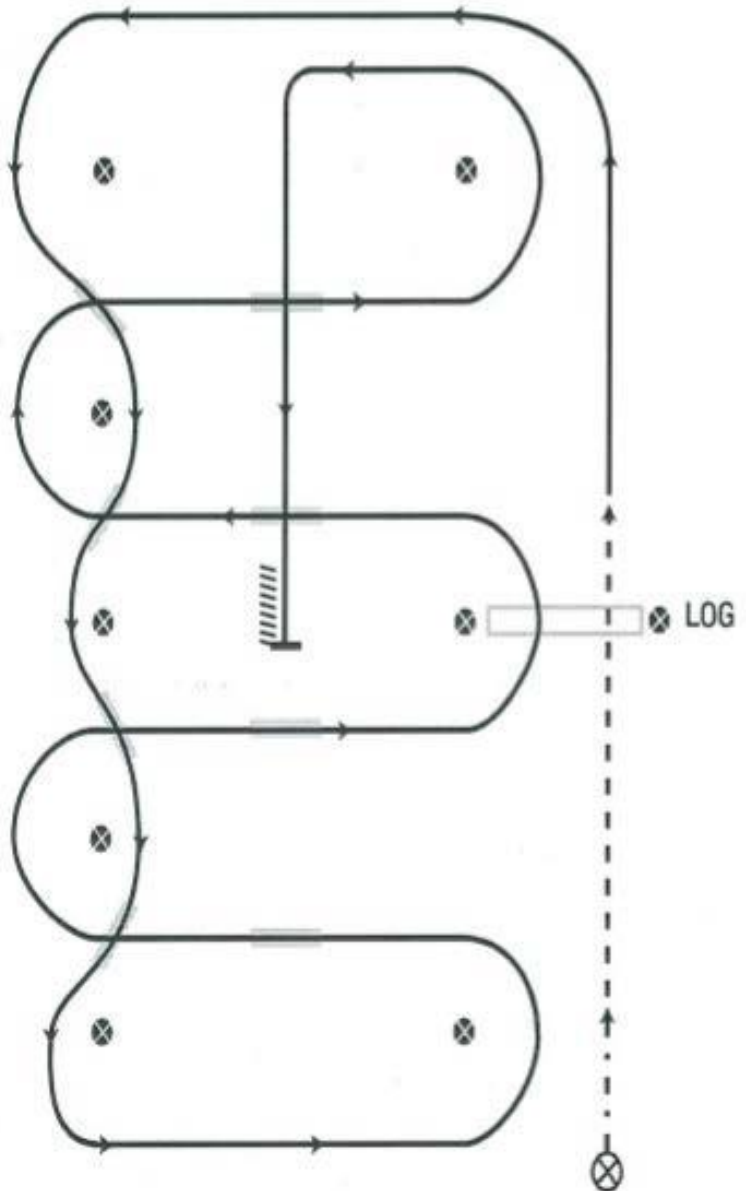

WESTERN RIDING- PATTERN 2

1. Walk, transition to jog, jog over log.
2. Transition to the lope, on the left lead.
3. First crossing change
4. Second crossing change
5. Third crossing change
6. Circle & first line change
7. Second line change
8. Third line change
9. Fourth line change & circle
10. Lope over log
11. Lope, stop & back

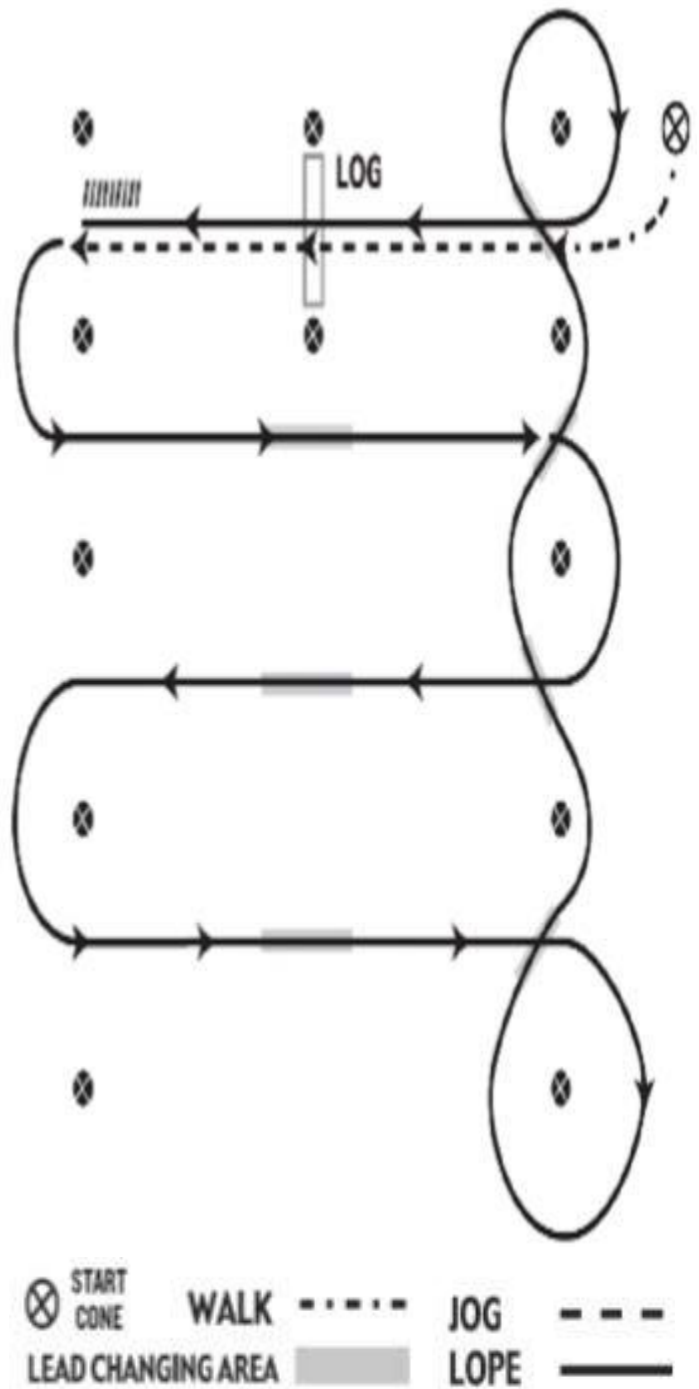

WESTERN RIDING- PATTERN 3

1. Walk halfway between markers, transition to jog. Jog over log.
2. Transition to the lope, on the left lead.
3. First crossing change.
4. Lope over log.
5. Second crossing change.
6. First line change.
7. Second line change.
8. Third line change.
9. Fourth line change.
10. Third crossing change.
11. Fourth crossing change.
12. Lope up the center, stop & back.

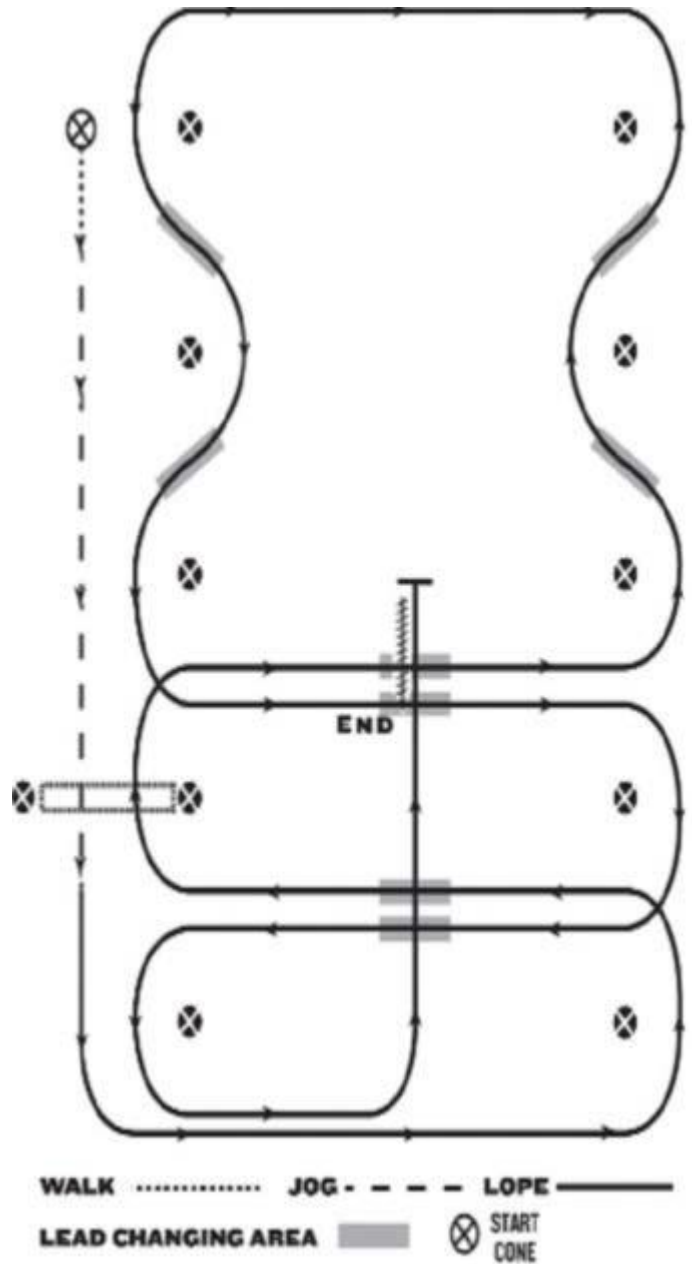

WESTERN RIDING- PATTERN 5

*recommended for small arenas

1. Walk, transition to jog, jog over log.
2. Transition to the lope, on the left lead.
3. First line change.
4. Second line change.
5. Third line change.
6. Fourth line change.
7. First crossing change.
8. Lope over log.
9. Second crossing change.
10. Third crossing change.
11. Fourth crossing change.
12. Lope, stop and back.

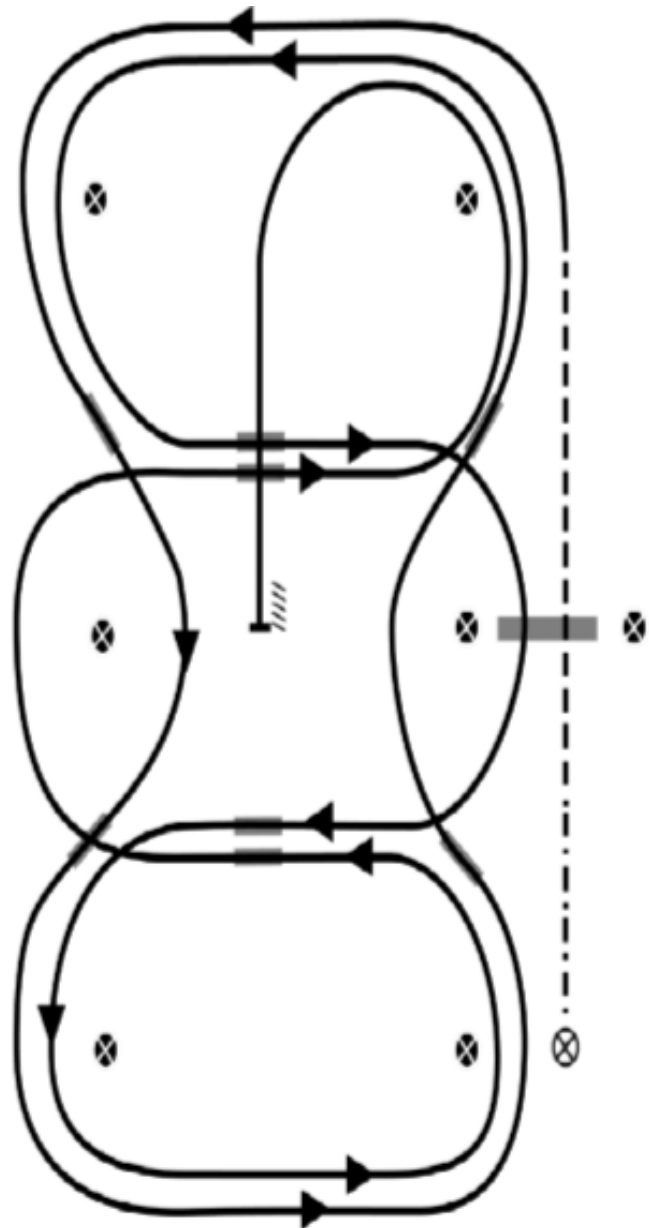

8.8 REINING

Reining is a judged event designed to show the athletic ability of a ranch type horse in the confines of a show arena. In reining competition, contestants are required to run one of several approved patterns. Each pattern includes small slow circles, large fast circles, flying lead changes, rollbacks over the hocks, a series of 360° spins done in place, and the exciting sliding stops that are the hallmark of the reining horse. To rein a horse is not only to guide him, but also to control his every movement. The best reined horse should be willingly guided or controlled with little or no apparent resistance and dictated to completely. Any movement on his own must be considered a lack of control. Any one of 15 approved reining patterns may be used and is to be selected by the judge of the class and used by all contestants in the class. Each contestant will perform the required pattern individually and separately. All horses will be judged immediately upon entering the arena. Any fault incurred prior to the commencement of the pattern will be scored accordingly. All deviations from the exact written pattern must be considered a lack of or temporary loss of control, and therefore faulted according to severity of deviation. Credit will be given for smoothness, finesse, attitude, quick-ness and authority in performing the various maneuvers while using controlled speed.

a. Scoring will be based on 0 – infinity, with 70 denoting an average performance. Maneuver scores will be as follows:

+1 ½ Excellent; +1 Very Good; +½ Good; 0 Correct; -½ Poor; -1 Very Poor; -1 ½ Extremely Poor

b. The following will result in a no score:

Abuse of an animal in the show arena and/or evidence that an act of abuse has occurred prior to or during the exhibition of a horse in competition

Use of illegal equipment, including wire on bits, bosals, or curb chains

Use of illegal bits, bosals or curb chains; when using a snaffle bit, optional curb strap is acceptable; however, curb chains are not acceptable

Use of tack collars, tie downs or nosebands

Use of whips or bats

Use of any attachment which alters the movement of or circulation to the tail

Failure to provide horse and equipment to judge for inspection when requested

Disrespect or misconduct by the exhibitor

Closed reins are not allowed except as standard romal reins

Excess rein may be straightened anytime during the pattern, provided the riders free hand remains behind the rein hand. Any attempt to alter tension or length of the reins from the bridle to the rein hand is to be considered use of two hands and a penalty score of 0 (zero) will be applied. In being used to instill fear or praise, a penalty 5 (five) will be applied, and a reduction in the maneuver score.

c. The following will result in a 0 score:

Use of more than index or first finger between reins

Use of two hands (except for a junior horse wearing a snaffle bit or bosal) or changing hands

Improper use of romal reins

Failure to complete pattern as written

Performing the maneuvers other than in specified order

The inclusion of maneuvers not specified, including but not limited to backing more than 2 strides or turning more than 90 degrees

Equipment failure that delays completion of pattern, including dropping a rein that contacts the ground while horse is in motion

Balking or refusal of command where performance is delayed

Running away or failing to guide where it becomes impossible to discern whether the entry is on pattern

Over spins of more than 3/4 turn

Fall to the ground by horse or rider

When going to and coming out of a rollback in a pattern requiring a run-around, a roll-back that crosses the center line
MWHS Rulebook revised for above section 2006, 2015

d. Neither a no score or a 0 score are eligible to place

e. The following will result in a penalty of 1/2:

Starting a circle at a jog or exiting rollbacks at a jog up to two strides

Over or under spinning up to 1/8 of a turn

Failure to remain a minimum of 20 feet (6 m) from the wall or fence when approaching a stop and/or rollback

Delayed change of lead by one stride where the lead change is required by the pattern description

Failing to remain a minimum of 10 feet (3 m) from either side of the center of the arena. For small arena's it will be at the judge's discretion

f. The following will result in a penalty of 1:

In patterns requiring a run around, failure to be on the correct lead when rounding the end of the arena for 1/2 turn or less

Each time a horse is out of lead, a judge is required to deduct one point. The penalty for being out of lead is accumulative and the judge will deduct one penalty point for each quarter of the circumference of a circle or any part there of that a horse is out of lead

Over or under spinning from 1/8 to 1/4 turn

g. The following will result in a penalty of 2:

Break of gait

Freeze up in spins or rollbacks

On walk in patterns, failure to stop or walk before executing canter departure

On run in patterns, failure to be in a canter prior to first marker

If a horse does not completely pass the specified marker before initiating a stop position

Jogging beyond two strides, but less than 1/2 circle or 1/2 the length of the arena

In patterns requiring a run around, failure to be on the correct lead when rounding the end of the arena for 1/2 turn or more

MWHS Rulebook revised for above section 2006, 2015

h. The following will result in a penalty of 5:

Spurring in front of the cinch

Use of either hand to install fear or praise

Holding the saddle with either hand

Blatant disobedience including kicking, biting, rearing, bucking and striking

i. Faults against the horse to be scored accordingly, but not to cause disqualification include:

Opening mouth excessively when wearing bit

Excessive jawing, opening mouth or head raising on stops

Lack of smooth, straight stops on haunches, bouncing or sideways stops

Refusing to change leads

Anticipating signals

Stumbling

Backing sideways

Knocking over markers

j. Faults against the rider are to be scored accordingly, but not to cause disqualifications include:

Losing stirrup

Failure to run circles or figure eights within the markers is not considered a fault depending on arena conditions and size however, failure to go beyond markers on rollbacks and stops is considered a fault

MWHS Rulebook revised for above section 2006, 2014, 2015

8.8.1 REINING PATTERNS

- a. The following patterns will be worked as stated, not as drawn. The drawn pattern is just to give the general idea of what the pattern will look like in the arena.
- b. Markers are to be placed on the rail to mark the center of the arena and the points at each end to be passed for the rollbacks.
The figure eights and circles do not have to be run within the end markers.
- c. Where stops are designated to be beyond a marker, the horse should begin his stop after he passes the marker.
- d. Each pattern is drawn so that the bottom of the page represents the end of the arena entered by the contestants and must be run as such. In the event the arena has only one gate and it is in the exact middle of the side, that side shall represent the right side of the page that the pattern is drawn on.



MWHS REINING

Scoring will be on the basis of zero – infinity with 70 denoting average.

JUDGE
CLASS
DATE

Penalty 1/2:

Starting circle at a jog or exiting rollbacks at a jog up to 2 strides.
 Over or under spinning up to 1/8 of a turn.
 Failure to remain a minimum of 20 feet (9m) from the wall or fence when approaching a stop or rollback.
 Delayed change of lead by one stride where the lead change is required by the pattern description.
 Failure to remain a minimum of 10 feet (3 m) from either side of the center of the arena. For small arenas, it will be at the judge's discretion.

Penalty 1:

Each time a horse is out of lead, the penalty for being out of lead is accumulative and the judges will deduct on penalty point for each quarter of the circumference of a circle or any part there of that a horse is out of lead.
 Over or under spinning 1/8 to 1/4 turn.
 In patterns requiring a run around, failure to be on the correct lead when rounding the end of the arena for 1/2 the turn or less.

Penalty 2:

Break of gait.
 Freeze up in spins or rollbacks.
 On walk in patterns, failure to stop or walk before executing a canter departure.
 On run in patterns, failure to be in a canter prior to the first marker.
 If a horse does not completely pass the specified marker before initiating a stop position.
 In patterns requiring a run around, failure to be on the correct lead when rounding the end of the arena for 1/2 the turn or more.

Penalty 5:

Spurring in front of the cinch.
 Use of either hand to instill fear or praise.
 Holding saddle with either hand.
 Blatant disobedience including kicking, biting, bucking, rearing and striking.

Score 0:

Use of more than index or first finger between reins.
 Use of 2 hands (except Jr. Horse with snaffle or bosal) or changing hands.
 Improper use of romal reins.
 Failure to complete a pattern as written.
 Performing maneuvers other than in the specified order.
 The inclusion of maneuvers not specified, including, but not limited to: backing more than two strides or turning more than 90°.
 Equipment failure that delays completion of pattern including dropping a rein that contacts the ground while horse is in motion.
 Balking or refusing of a command where performance is delayed, delaying the pattern.
 Running away or failing to guide where it becomes impossible to discern whether the entry is on pattern.
 Jogging in excess of 1/2 circle or 1/2 length of the arena.
 Over spins or more than 1/4 turn.
 Fall to the ground of horse or rider.
 When going to and coming out of a rollback in a pattern requiring a run around, a rollback that crosses the center line.

MANEUVER SCORES: -1 1/2 Extremely Poor -1 Very Poor -1/2 Poor 0 Correct +1/2 Good +1 Very Good +1 1/2 Excellent

MANEUVER DESCRIPTION										PENALTY	SCORE
MANEUVER		1	2	3	4	5	6	7	8	TOTAL	
DRAW	EXH#	PENALTY								↓	SCORE
		SCORE									
DRAW	EXH#	PENALTY								↓	SCORE
		SCORE									
DRAW	EXH#	PENALTY								↓	SCORE
		SCORE									
DRAW	EXH#	PENALTY								↓	SCORE
		SCORE									
DRAW	EXH#	PENALTY								↓	SCORE
		SCORE									
DRAW	EXH#	PENALTY								↓	SCORE
		SCORE									

Judge's Signature _____

REINING PATTERN 1

RIDER MUST NOTIFY JUDGE *BEFORE* STARTING PATTERN WHETHER DOING TWO OR FOUR SPINS.

1. Run at speed to the far end of the arena past the end marker and do a left rollback - no hesitation.
2. Run to the opposite end of the arena past the end marker and do a right rollback - no hesitation.
3. Run past the center marker and do a sliding stop. Back up to center of the arena or at least 10 feet (3 meters). Hesitate.
4. Complete two or four spins to the right.
5. Complete two and one quarter or four and one quarter spins to the left so that horse is facing left wall or fence. Hesitate.
6. Beginning on left lead, complete three circles to the left: the first circle large and fast; the second circle small and slow; the third circle large and fast. Change leads at the center of the arena.
7. Complete three circles to the right: the first circle large and fast; the second circle small and slow; the third circle large and fast. Change leads at the center of the arena.
8. Begin a large fast circle to the left but do not close this circle. Run straight up the right side of the arena past the center marker. Do a sliding stop at least 20 feet (6 meters) from wall or fence. Hesitate to demonstrate the completion of the pattern.

Rider may drop bridle to Judge.

MWHS Rulebook revised for above section 2004

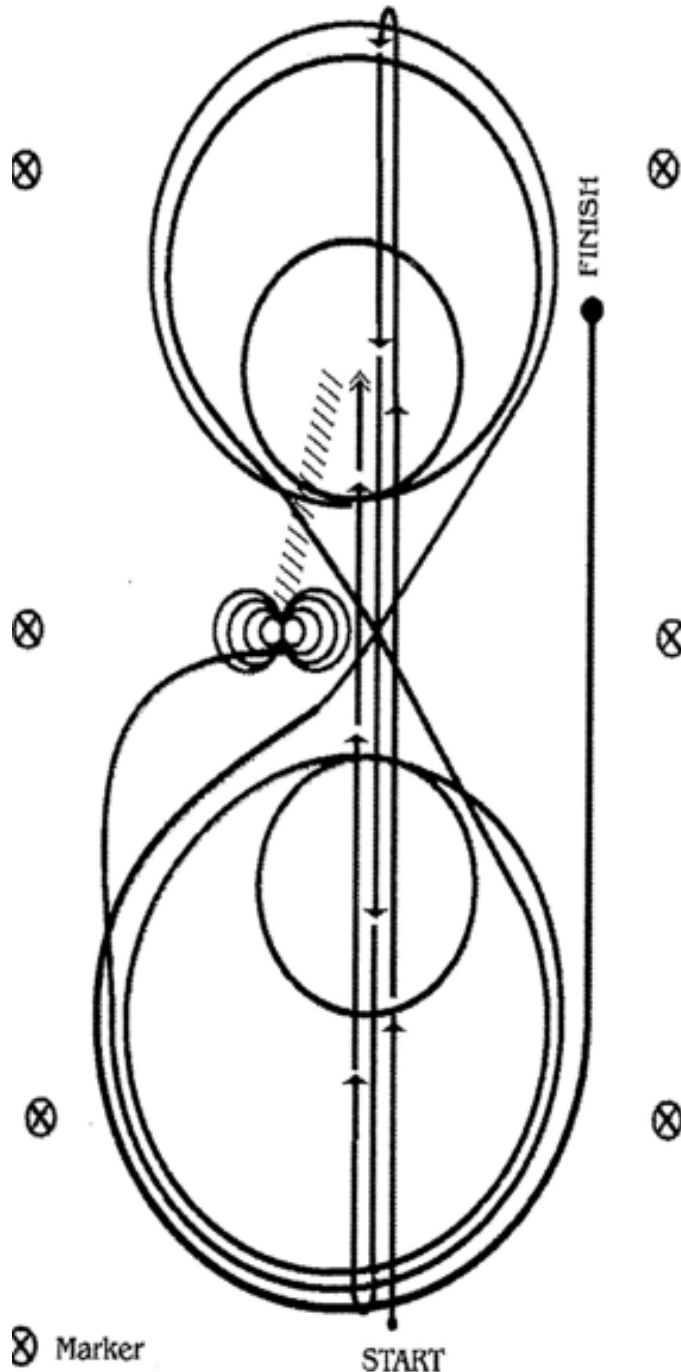

REINING PATTERN 2

RIDER MUST NOTIFY JUDGE *BEFORE* STARTING PATTERN WHETHER DOING TWO OR FOUR SPINS.

Horse must walk or stop prior to starting pattern
Beginning at the center of the arena facing the left wall or fence.

1. Beginning on the right lead, complete three circles to the right: the first circle small and slow, the next two circles large and fast. Change leads at the center of the arena.
2. Complete three circles to the left: the first circle small and slow; the next two circles large and fast. Change leads at the center of the arena.
3. Continue around previous circle to the right. At the top of the circle, run down the middle to the far end of the arena past the end marker and do a right rollback - no hesitation.
4. Run up the middle to the opposite end of the arena past the end marker and do a left rollback - no hesitation.
5. Run past the center marker and do a sliding stop. Back up to the center of the arena or at least 10 feet (3 meters). Hesitate.
6. Complete two or four spins to the right. Hesitate.
7. Complete two or four spins to the left. Hesitate to demonstrate the completion of the pattern.

Rider may drop bridle to Judge

MWHS Rulebook revised for above section 2004

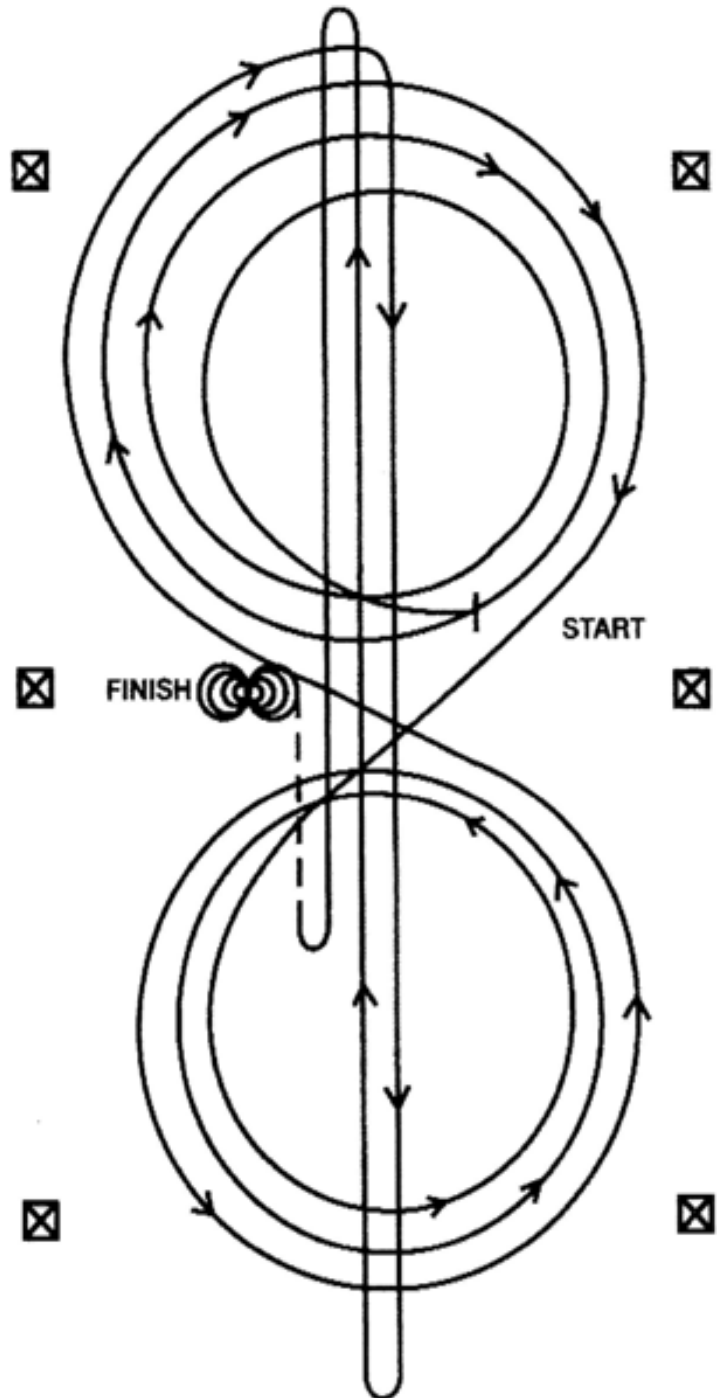

REINING PATTERN 3

RIDER MUST NOTIFY JUDGE *BEFORE* STARTING PATTERN WHETHER DOING TWO OR FOUR SPINS

1. Beginning and staying at least 20 feet (6 meters) from the walls or fence, lope straight up the left side of the arena, circle the top end of the arena, run straight down the opposite or right side of the arena past the center marker and do a left rollback - no hesitation.
2. Continue straight up the right side of the arena staying at least 20 feet (6 meters) from the wall or fence, circle back around the top of the arena, run straight down the left side of the arena past the center marker and do a right rollback - no hesitation.
3. Continue up the left side of the arena to the center marker. At the center marker, the horse should be on the right lead. Guide the horse to the center of the arena on the right lead and complete three circles to the right: the first two circles large and fast: the third circle small and slow. Change leads at center of arena.
4. Complete three circles to the left: the first two circles large and fast: the third circle small and slow. Change leads at the center of the arena.
5. Begin a large fast circle to the right but do not close this circle. Continue up the left side of the arena staying at least 20 feet (6 meters) from the wall or fence, circle the top of the arena, run straight down the opposite side of the arena past the center marker and do a sliding stop. Back up at least 10 feet (3meters). Hesitate.
6. Complete two or four spins to the right.
7. Complete two or four spins to the left. Hesitate to demonstrate completion of the pattern.

Rider may drop bridle to Judge.

MWHS Rulebook revised for above section 2004

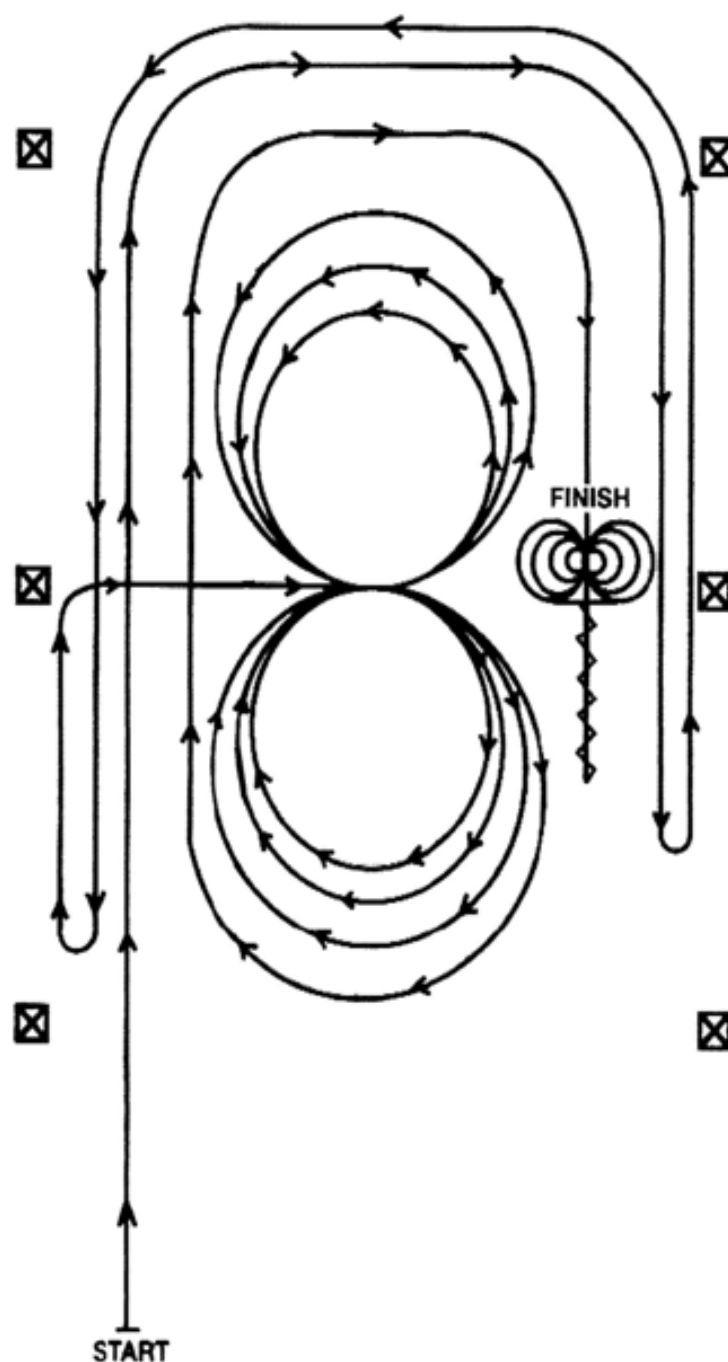

REINING PATTERN 4

RIDER MUST NOTIFY JUDGE *BEFORE* STARTING PATTERN WHETHER DOING TWO OR FOUR SPINS

Horse must walk or stop prior to starting pattern.
Beginning at the arena facing the left wall or fence.

1. Beginning on the right lead complete three circles to the right: the first two circles large and fast; the third circle small and slow. Stop at the center of the arena.
2. Complete two or four spins to the right. Hesitate.
3. Beginning on the left lead, complete three circles to the left: the first two circles large and fast; the third circle small and slow. Stop at the center of the arena.
4. Complete two or four spins to the left. Hesitate.
5. Beginning on the right lead, run a large fast circle to the right, change leads at the center of the arena, run a large fast circle to the left, and change leads at the center of the arena.
6. Continue around the previous circle to the right. At the top of the circle, run down the middle to the far end of the arena past the end marker and do a right rollback - no hesitation.
7. Run up the middle to the opposite end of the arena past the end marker and do a left roll back - no hesitation.
8. Run past center marker and do a sliding stop. Back up to the center of the arena or at least 10 feet (3 meters). Hesitate to demonstrate completion of the pattern.

Rider may drop bridle to Judge.

MWHS Rulebook revised for above section 2004

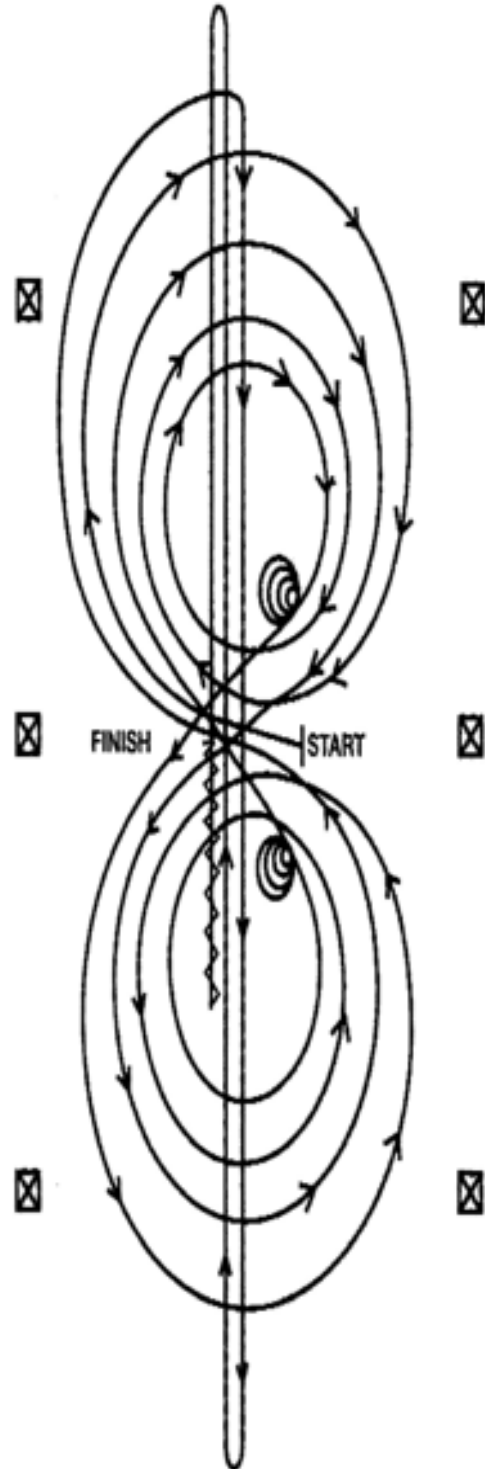

REINING PATTERN 5

RIDER MUST NOTIFY JUDGE *BEFORE* STARTING PATTERN WHETHER DOING TWO OR FOUR SPINS

Horse must walk or stop prior to starting pattern

Beginning at the center of the arena facing the left wall.

1. Beginning on the left lead, complete three circles to the left: the first two circles large and fast; the third circle small and slow. Stop at the center of the arena.
2. Complete two or four spins to the left. Hesitate.
3. Beginning on the right lead complete three circles to the right: the first two circles large and fast; the third circle small and slow. Stop at center of the arena.
4. Complete two or four spins to the right.
5. Beginning on the left lead, run a large fast circle to the left, change leads at the center of the arena, run a large fast circle to the right, and change leads at the center of the arena. (Figure 8)
6. Continue around previous circle to the left but do not close this circle. Run up the right side of the arena past the center marker and do a right rollback at least 20 feet (6 meters) from the wall or fence - no hesitation.
7. Continue around previous circle but do not close this circle. Run up the left side of the arena past the center marker and do a left rollback at least 20 feet (6meters) from wall or fence - no hesitation.
8. Continue back around previous circle but do not close this circle. Run up the right side of the arena past the center marker and do sliding stop at least 20 feet (6meters) from the wall or fence. Back up the least 10 feet (3 meters). Hesitate to demonstrate completion of pattern.

Rider may drop bridle to the Judge.

MWHS Rulebook revised for above section 2004

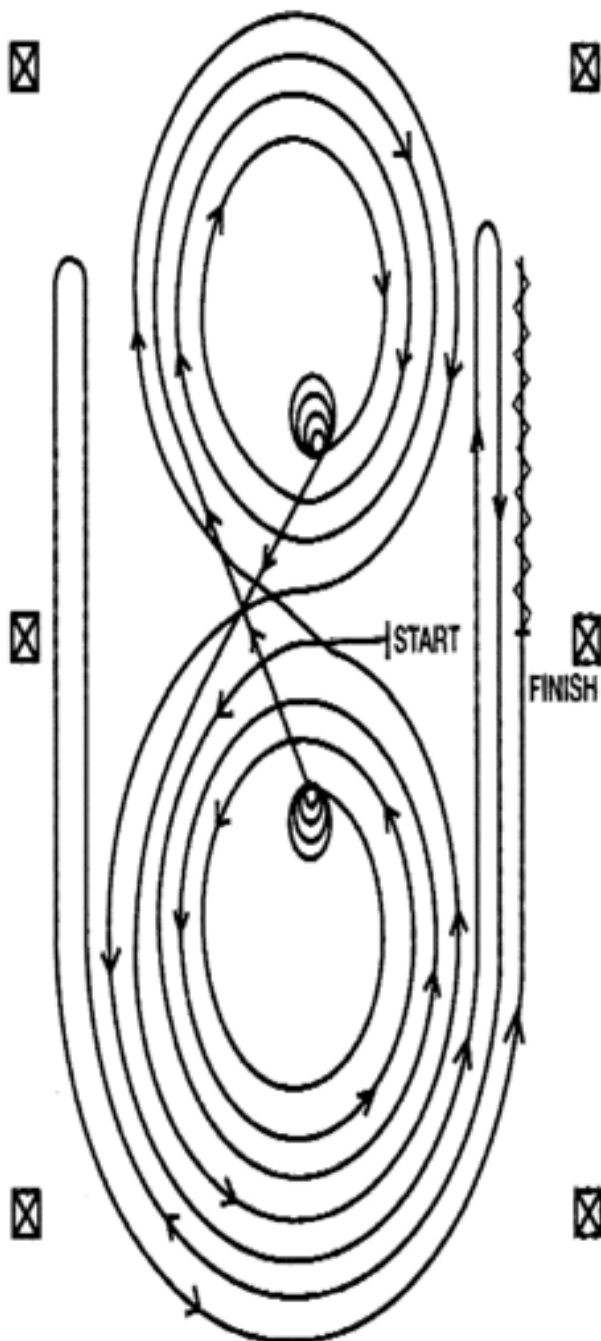

REINING PATTERN 6

RIDER MUST NOTIFY JUDGE *BEFORE* STARTING PATTERN WHETHER DOING TWO OR FOUR SPINS

Horse must walk or stop prior to starting pattern
Beginning at the center of the arena facing the left wall or fence.

1. Complete two or four spins to the right.
2. Complete two or four spins to the left. Hesitate.
3. Beginning on the left lead complete three circles to the left: the first two circles large and fast; the third circle small and slow. Change leads at the center of the arena.
4. Complete three circles to the right: the first two circles large and fast; the third circle small and slow. Change leads at the center of the arena.
5. Begin a large fast circle to the left but not close this circle. Run up the right side of the arena past the center marker and do a right rollback at least 20 feet (6 meters) from the wall or fence - no hesitation.
6. Continue back around previous circle but do not close this circle. Run up the left side of the arena past the center marker and do a left roll-back at least 20 feet (6 meters) from the wall or fence - no hesitation.
7. Continue back around previous circle but do not close this circle. Run up the right side of the arena past the center marker and do sliding stop at least 20 feet (6 meters) from the wall or fence. Back up at least 10 feet (3 meters). Hesitate to demonstrate completion of pattern.

Rider may drop bridle to Judge

MWHS Rulebook revised for above section 2004

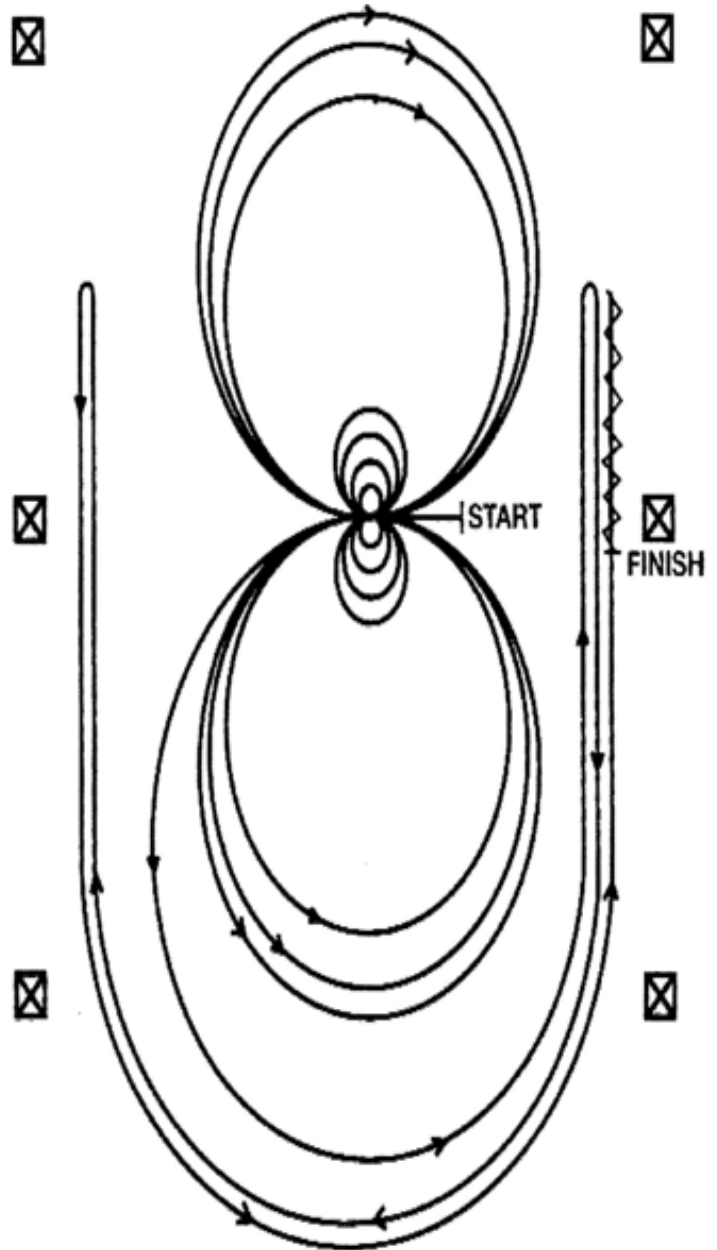

REINING PATTERN 7

RIDER MUST NOTIFY JUDGE *BEFORE* STARTING PATTERN WHETHER DOING TWO OR FOUR SPINS

1. Run at speed to the far end of the arena past the end marker and do a left rollback - no hesitation.
2. Run to the opposite end of the arena past the end marker and do a right rollback - no hesitation.
3. Run past the center marker and do a sliding stop. Back up to the center of the arena at least 10 feet (3 meters). Hesitate.
4. Complete two or four spins to the right.
5. Complete two and one quarter or four and one quarter spins to the left so that the horse is facing the left wall or fence. Hesitate.
6. Beginning on the right lead complete three circles to the right: the first two circles large and fast; the third circle small and slow. Change leads at the center of the arena.
7. Complete three circles to the left: the first two circles large and fast; the third circle small and slow. Change leads at the center of the arena.
8. Begin a large fast circle to the right but do not close this circle. Run straight down the right side of the arena past the center marker and do a sliding stop at least 20 feet (6 meters) from the wall or fence. Hesitate to demonstrate completion of the pattern.

Rider may drop bridle to Judge.

MWHS Rulebook revised for above section 2004

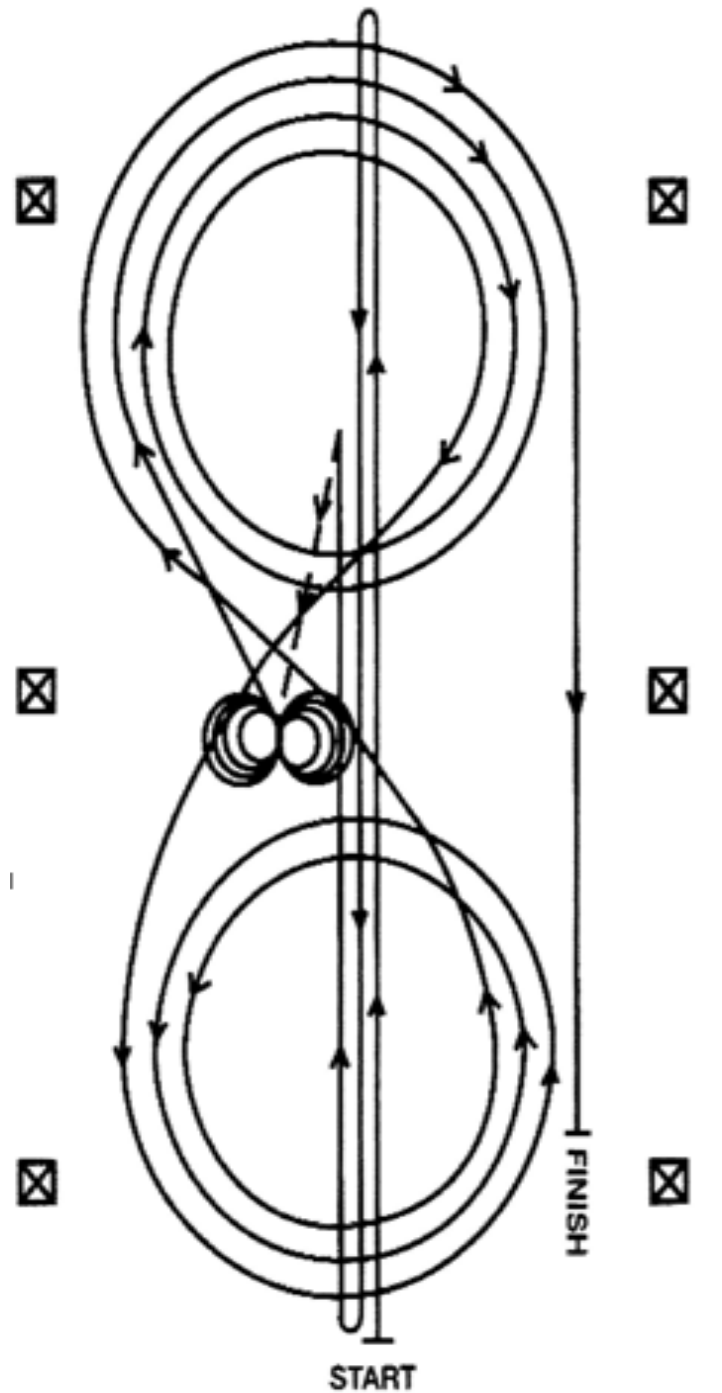

REINING PATTERN 8

RIDER MUST NOTIFY JUDGE *BEFORE* STARTING PATTERN WHETHER DOING TWO OR FOUR SPINS

Horse must walk or stop prior to starting pattern
Walk horse to center of the arena facing the left wall or fence.

1. Complete two or four spins to the left.
2. Complete two or four spins to the right. Hesitate.
3. Beginning on the right lead, complete three circles to the right: the first circle large and fast; the second circle small and slow; the third circle large and fast. Change leads at the center of the arena.
4. Complete three circles to the left: the first circle large and fast; the second circle small and slow; the third circle large and fast. Change of leads at the center of the arena.
5. Begin a large fast circle to the right but do not close this circle. Run straight down the right side of the arena past the center marker and do a left rollback at least 20 feet (6 meters) from the wall or fence - no hesitation.
6. Continue back around the previous circle but do not close this circle. Run down the left side of the arena past the center marker and do a right rollback at least 20 feet (6 meters) from the wall or fence - no hesitation.
7. Continue back around the previous circle but do not close this circle. Run down the right side of the arena past the center marker and do a sliding stop at least 20 feet (6 meters) from the wall or fence. Back up at least 10 feet (3 meters). Hesitate to demonstrate completion of the pattern.

Rider may drop bridle to Judge.

MWHS Rulebook revised for above section 2004

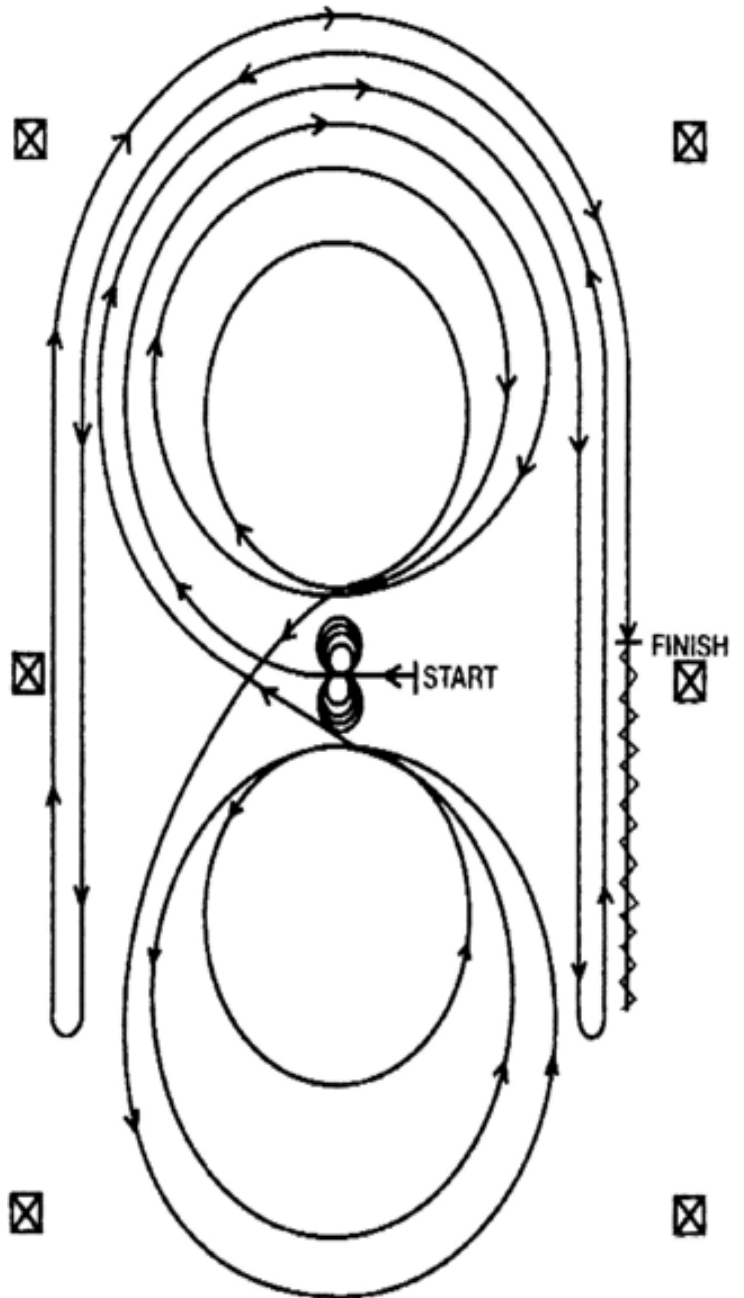

REINING PATTERN 9

RIDER MUST NOTIFY JUDGE *BEFORE* STARTING PATTERN WHETHER DOING TWO OR FOUR SPINS

1. Run past the center marker and do a sliding stop. Back up to the center of the arena or least 10 feet (3 meters). Hesitate.
2. Complete two or four spins to the right.
3. Complete two and one-quarter or four and one-quarter spins to the left so that the horse is facing the left wall or fence. Hesitate.
4. Beginning on the left lead complete three circles to the left: the first circle small and slow; the next two circles large and fast. Change leads at the center of the arena.
5. Complete three circles to the right: the first circle small and slow; the next two circles large and fast. Change leads at the center of the arena.
6. Begin a large fast circle to the left but do not close this circle. Run up the right side of the arena past the center marker and do a right roll back at least 20 feet (6 meters) from the wall or fence - no hesitation.
7. Continue back around the previous circle but do not close this circle. Run up the left side of the arena past the center marker and do a left roll-back at least 20 feet (6 meters) from the wall of fence - no hesitation.
8. Continue back around the previous circle but do not close this circle. Run up the right side of the arena past the center marker and do a sliding stop at least 20 feet (6 meters) from the wall or fence. Hesitate to demonstrate completion of the pattern.

Rider may drop bridle to Judge.

MWHS Rulebook revised for above section 2004

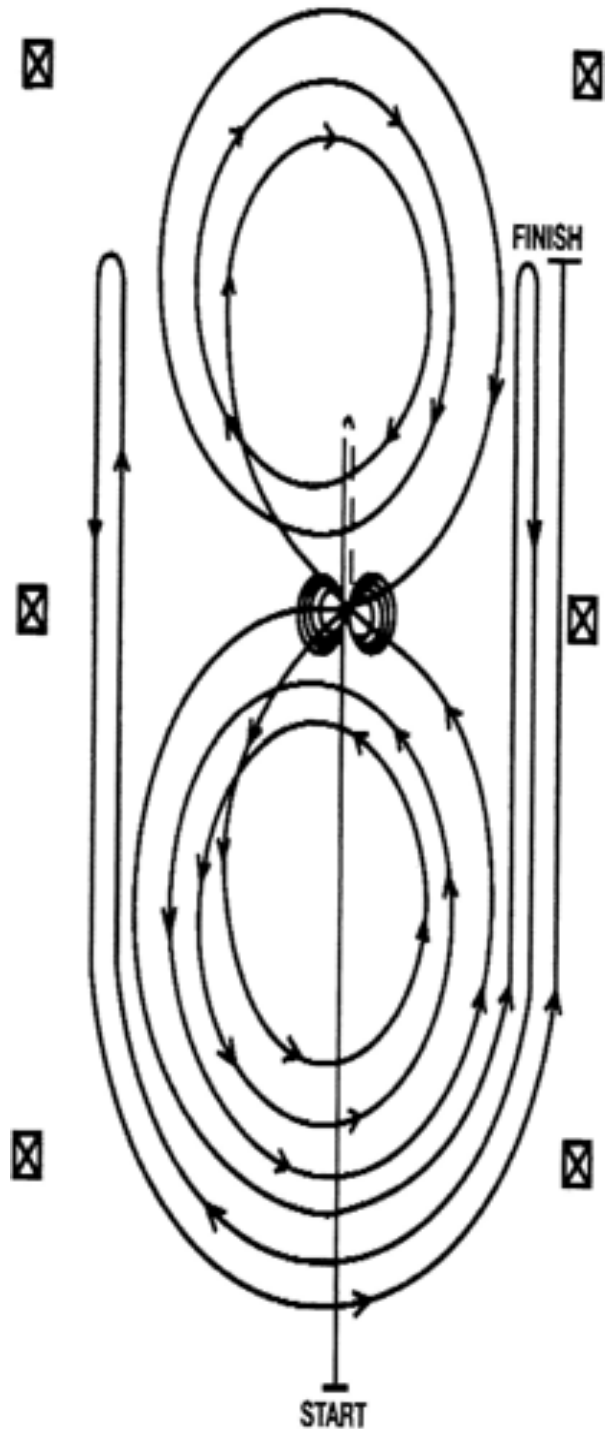

REINING PATTERN 10

RIDER MUST NOTIFY JUDGE *BEFORE* STARTING PATTERN WHETHER DOING TWO OR FOUR SPINS

1. Run past the center marker and do a sliding stop. Back up to the center of the arena or at least 10 feet (3 meters). Hesitate.
2. Complete two or four spins to the right.
3. Complete two and one-quarter or four and one-quarter spins to the left so that the horse is facing the left wall or fence. Hesitate.
4. Beginning on the right lead, complete three circles to the right; the first two circles large and fast, the third circle small and slow. Change leads at the center of the arena.
5. Complete three circles to the left; the first circle small and slow, the next two circles large and fast. Change leads at the center of the arena.
6. Begin a large fast circle to the right but do not close this circle. Run down the right side of the arena past marker and do a left rollback at least 20 feet (6 meters) from the wall or fence - no hesitation.
7. Continue back around the previous circle but do not close this circle. Run down the left side of the arena past the center and do a right roll-back at least 20 feet (6 meters) from the wall or fence - no hesitation.
8. Continue back around previous circle but do not close this circle. Run down the right side of the arena past the center marker and do a sliding stop at least 20 feet (6 meters) from the wall or fence. Hesitate to demonstrate completion of the pattern.

Rider may drop bridle to Judge.

MWHS Rulebook revised for above section 2011, 2014

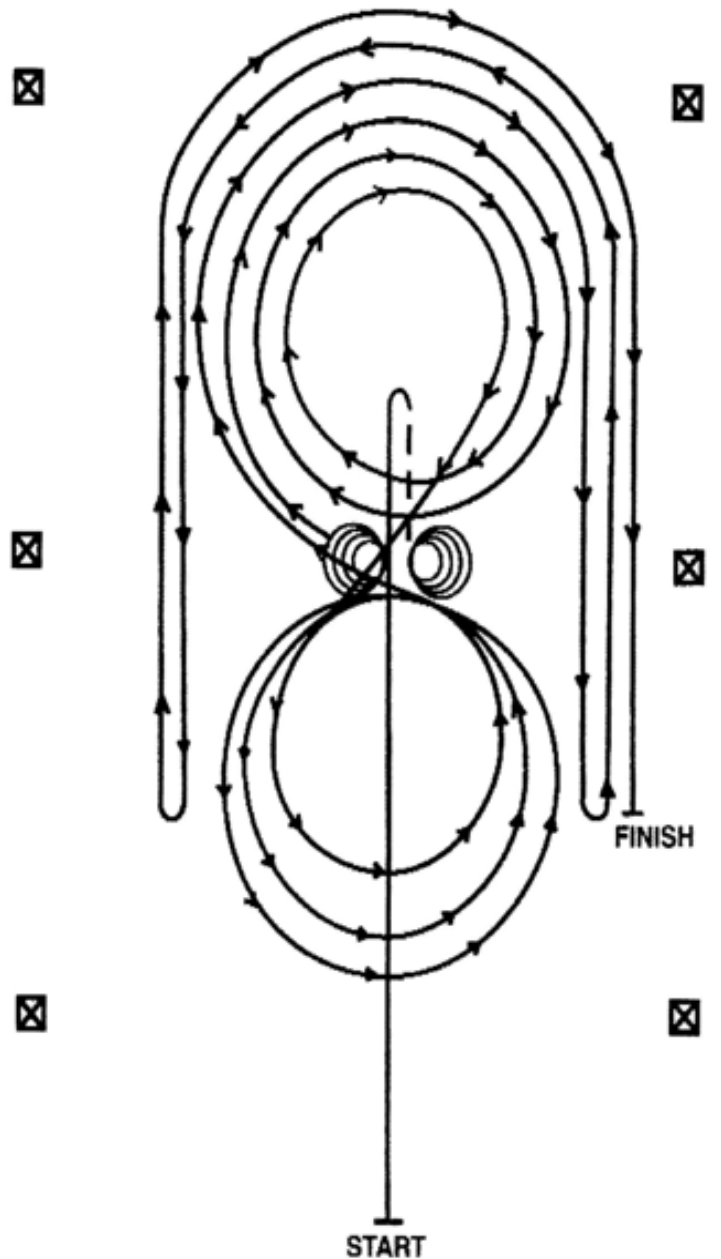

REINING PATTERN 11

RIDER MUST NOTIFY JUDGE *BEFORE* STARTING PATTERN WHETHER DOING TWO OR FOUR SPINS

Horses must jog the majority of the way to the center. Failure to jog the majority of the way to the center will result in a 0 for failure to complete the pattern as written.

Horses must walk or stop prior to starting pattern.

Beginning at the center of the arena facing the left wall or fence.

1. Complete two or four spins to the left. Hesitate.
2. Complete two or four spins to the right. Hesitate.
3. Beginning on the right lead, complete three circles to the right; the first circle small and slow; the next two circles large and fast. Change leads at the center of the arena.
4. Complete three circles to the left; the first circle small and slow; the next two circles large and fast. Change leads at the center of the arena.
5. Begin a large circle to the right, but do not close this circle. Run down the center of the arena past the end marker and do a right rollback - no hesitation.
6. Run up the middle to the opposite end of the arena past the end marker and do a left rollback - no hesitation.
7. Run past the center marker and do a sliding stop. Back up to the center of the arena or at least 10 feet (3 meters). Hesitate to demonstrate completion of the pattern.

Rider may drop bridle to Judge.

MWHS Rulebook revised for above section 2011, 2014

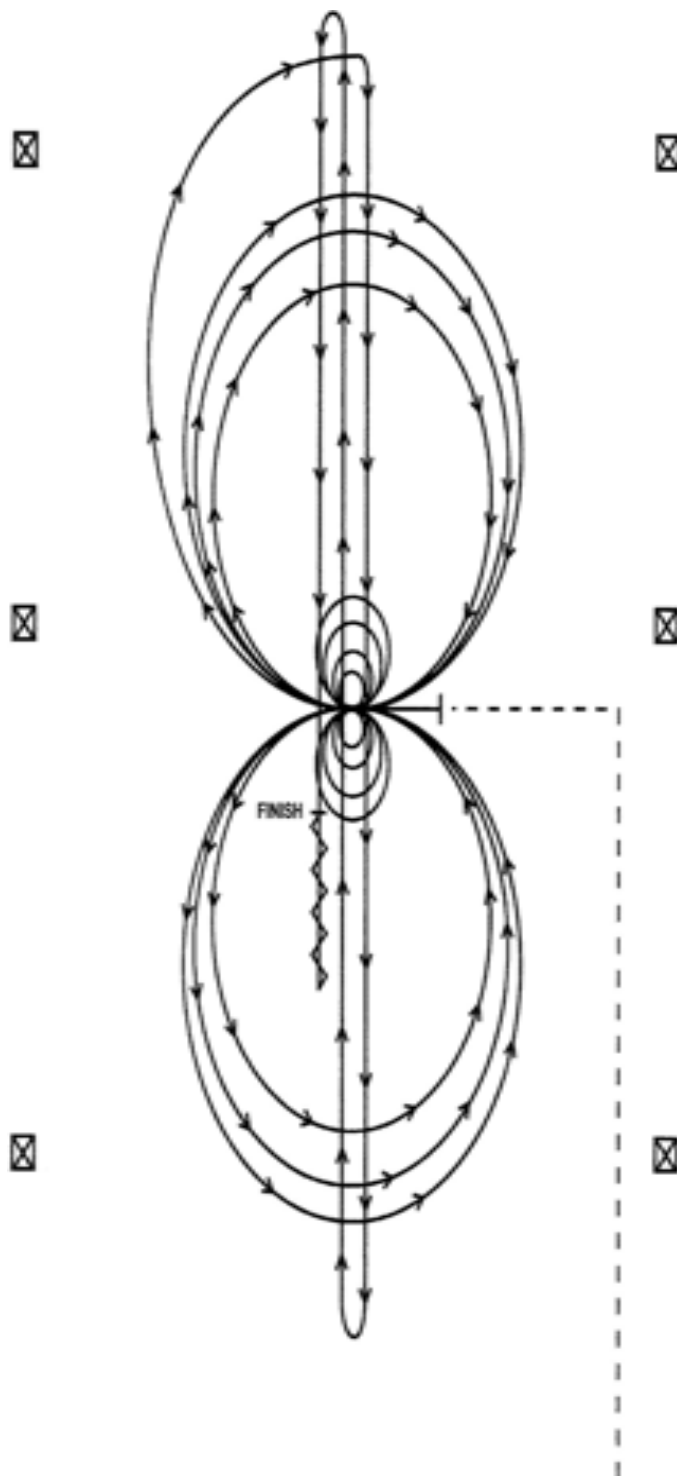

REINING PATTERN 13

RIDER MUST NOTIFY JUDGE *BEFORE* STARTING PATTERN WHETHER DOING TWO OR FOUR SPINS

Horses must walk or stop prior to starting pattern.

Beginning at the center of the arena facing the left wall or fence.

1. Beginning on the left lead, complete two circles to the left: the first circle large and fast: the second circle small and slow. Stop at the center of the arena.
2. Complete two or four spins to the left. Hesitate.
3. Beginning on the right lead, complete two circles to the right: the first being large and fast: the second circle small and slow. Stop at the center of the arena.
4. Complete two or four spins to the right. Hesitate.
5. Beginning on the left lead, run a large fast circle to the left, change leads at the center of the arena, run a large fast circle to the right, and change leads at the center of the arena.
6. Continue around the previous circle to the left but do not close this circle. Run up the right side of the arena past center marker and do a right rollback at least 20 feet (6 meters) from the wall or fence - no hesitation.
7. Continue around previous circle but do not close this circle. Run up the left side of the arena past the center marker and do a left rollback at least 20 feet (6 meters) from wall or fence - no hesitation.
8. Continue back around previous circle but do not close this circle. Run up the right side of the arena past the center marker and do a sliding stop at least 20 feet (6 meters) from the wall or fence. Back up at least 10 feet (3 meters).

Hesitate to demonstrate completion of the pattern.

Rider may drop bridle to Judge.

MWHS Rulebook revised for above section 2015

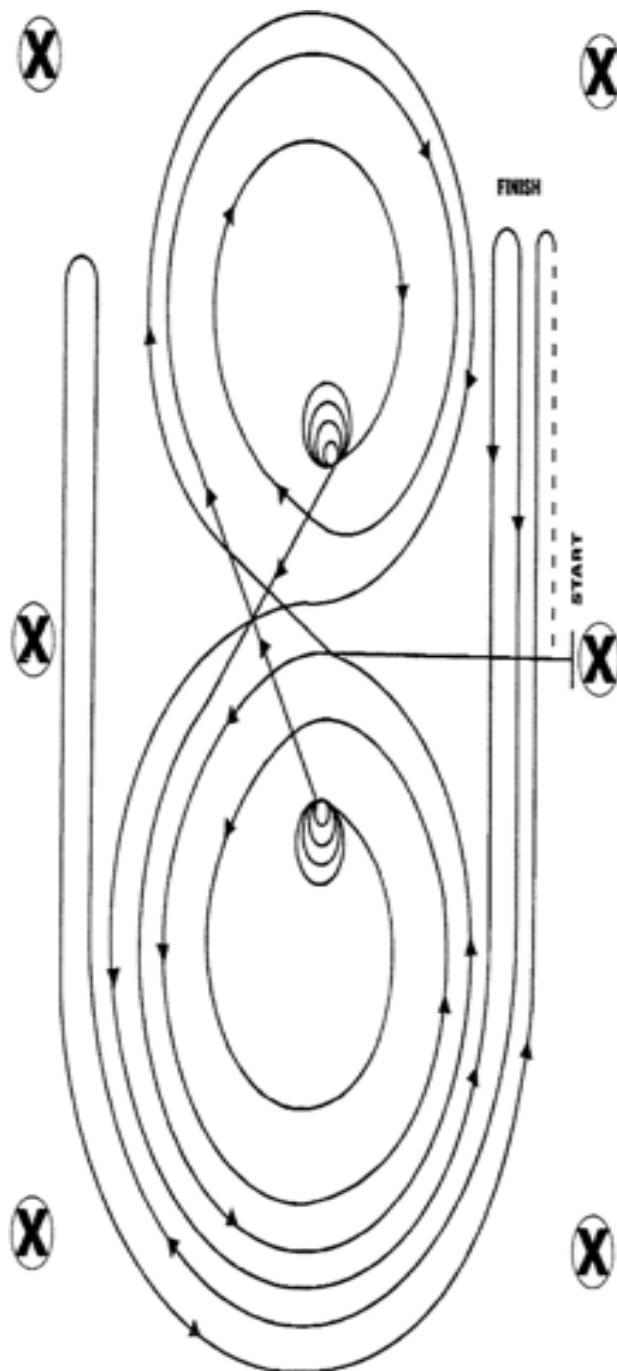

REINING PATTERN 14

RIDER MUST NOTIFY JUDGE *BEFORE* STARTING PATTERN WHETHER DOING TWO OR FOUR SPINS

Horses must walk or trot to the center of the arena.
Horses must walk or stop prior to starting the pattern.
Begin at the Centre of the arena facing the left wall or fence.

1. Beginning on the left lead, complete two circles to the left. Stop at the Centre of the arena. Hesitate.
2. Complete two or four spins to the left. Hesitate
3. Beginning on the right lead complete two circles to the right. Stop at the Centre of the arena. Hesitate.
4. Complete two or four spins to the right. Hesitate.
5. Beginning on the left lead, go around the end of the arena, run down the right side of the arena past Centre marker, stop and roll back right.
6. Continue around the end of the arena to run down the left side of the arena past the Centre marker. Stop. Back up.

Hesitate to show completion of pattern.
Rider may drop bridle to Judge.

MWHS Rulebook revised for above section 2015

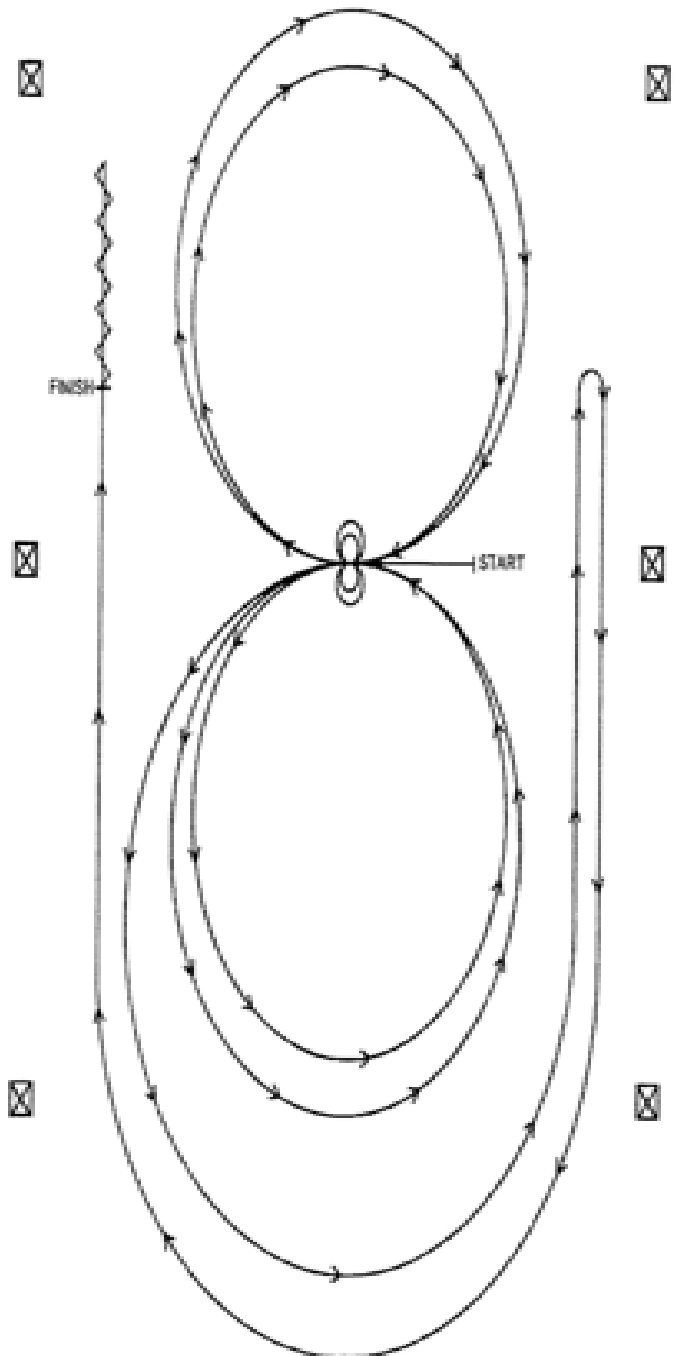

REINING PATTERN 15

RIDER MUST NOTIFY JUDGE *BEFORE* STARTING PATTERN WHETHER DOING TWO OR FOUR SPINS

1. Run around the end of the arena, run down the left side past Centre marker, right rollback
2. Run around end of arena, run down right side past center marker, left rollback
3. Left circles, one large fast and one small slow, stop at Centre
4. 3 spins left, hesitate
5. Right circles, one large fast and one small slow, stop at Centre
6. 3 spins right, hesitate
7. Begin large circle to left at the top of the circle, run down the center of the arena past center marker, stop and back up at least 10 feet (3 meters)

Hesitate to show completion of pattern
Rider may drop bridle to Judge.

MWHS Rulebook revised for above section 2015

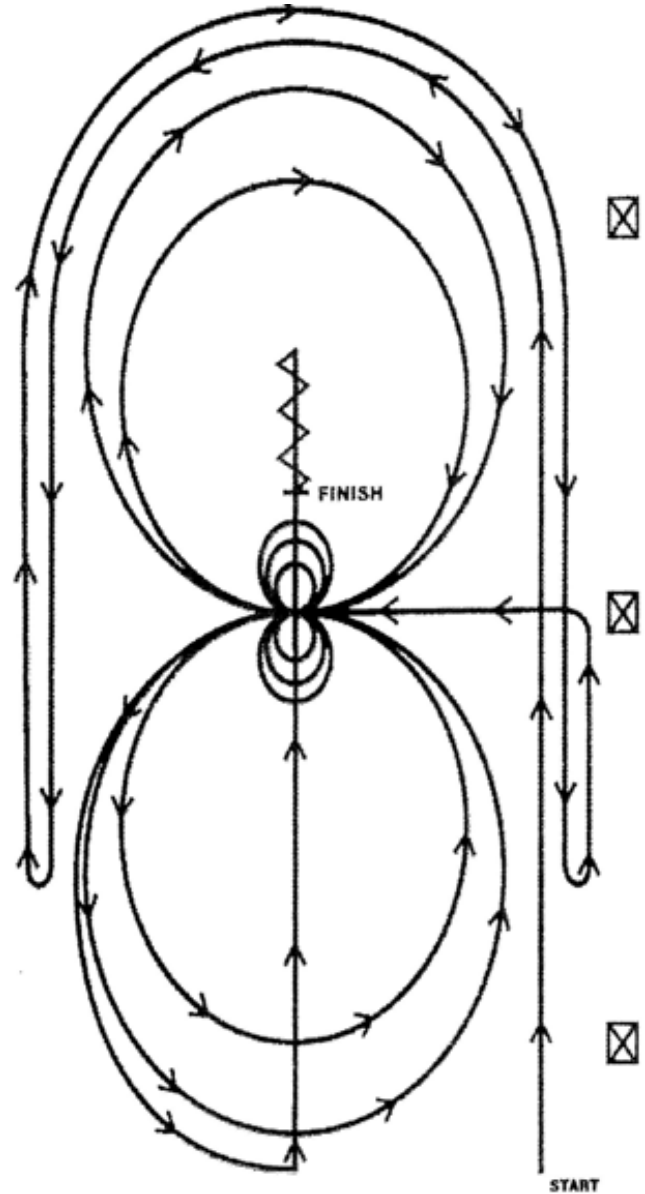

8.9 RANCH RIDING

At MWHS Approved shows, exhibitors will be allowed to show in the Open Western Pleasure, Jr. Horse Western Pleasure and Ranch Riding as well as Jr. A Western Pleasure

- a. The purpose of the Ranch Riding horse should reflect the versatility, attitude and movement of a working horse. The horse's performance should simulate a horse riding outside the confines of an arena and that of a working ranch horse. This class should show the horse's ability to work at a forward, working speed while under control by the rider. Light contact should be rewarded and horse shall not be shown on a full drape of reins. The overall manners and responsiveness of the horse while performing the maneuver requirements, and the horse's quality of movement are the primary considerations.
- b. Requirements:
 1. No horses less than 3 years of age.
 2. Each horse will work individually, performing both required and optional maneuvers, and scored on the basis of 0 to 100, with 70 denoting an average performance. Each maneuver will receive a score that should be added or subtracted from 70 and is subject to a penalty that should be subtracted. Each maneuver will be scored on the following basis, ranging from plus 1 1/2 to minus 1 1/2 extremely poor, -1 very poor, -1/2 poor, 0 correct, +1/2 good, +1 very good, +1 1/2 excellent. Maneuver scores are to be determined and assessed independently of penalty points.
 3. The required maneuvers will include the walk, trot and lope both directions and the extended trot and extended lope at least one direction as well as stops, and back.
 4. Three optional maneuvers may include a side pass, turns of 360 degrees or more, change of lead (simple or flying), walk, trot, or lope over a pole(s) or some reasonable combination of maneuvers that would be reasonable for a ranch horse to perform.
 5. The maneuvers may be arranged in various combinations with final approval by the judge.
 6. The overall cadence and performance of the gaits should be as those described below, with an emphasis on forward movement, free-flowing, and ground covering for all gaits. Transitions should be performed where designated, with smoothness and responsiveness. In all gaits, movement of the ranch riding horse should simulate a horse needing to cover long distances, softly and quietly, like that of a working ranch horse.
 - 6.1. The walk is a natural, flat-footed, four-beat gait. The gait is rhythmic and ground-covering. As in all gaits, the horse should display a level, or slightly above level top line with a bright expression.
 - 6.2. The trot is a natural two-beat gait demonstrating more forward motion than the western jog.
 - 6.3. The extended trot is an obvious lengthening of the stride with a definite increase in pace. The horse should be moving in a manner as if it were covering a large area on a ranch with an above level topline.
 - 6.4. The lope is a three-beat gait. The lope should be relaxed and smooth with a natural, forward moving stride.
 - 6.5. The extended lope is not a run or a race but should be an obvious lengthening of the stride, demonstrating a forward, working speed. The horse should display an above level topline with a bright, attentive expression.
 7. No time limit.
 8. One of the suggested patterns may be used, however a judge may utilize a different pattern as long as all required maneuvers are included and the 3 (or more) optional maneuvers are included. Should a judge use one of his/her own patterns, it is recommended to not have the stop following an extended lope.
 9. The use of natural logs is encouraged.
 10. Posting at the extended trot is acceptable.
 11. Touching or holding the saddle horn is acceptable.

- c. Apparel and Equipment: (encouraged but not mandatory)
1. No hoof polish.
 2. No braided or banded manes or tail extensions.
 3. Trimming inside ears is discouraged.
 4. Trimming bridle path is allowed, also trimming of fetlocks or excessive (long) facial hair.
 5. Equipment with silver should not count over a good working outfit. Silver on bridles and saddles is discouraged
 6. It is suggested competitors use a breast collar and a rear cinch.
- d. Scoring will be on the basis of 0 - infinity, with 70 denoting and average performance. Maneuver scores will be as follows:
+1 ½ Excellent; +1 Very Good; + ½ Good; 0 Correct; -½ Poor; -1 Very Poor; -1 ½ Extremely Poor.
- e. The following will result in a 1 (one) point penalty:
- Too slow per gait
 - Over bridled
 - Out of frame
 - Break of gait at walk or jog for 2 strides or less
- f. The following will result in a 3 (three) point penalty:
- Break of gait at walk or jog for more than 2 strides
 - Break of gait at lope
 - Wrong lead or out of lead
 - Draped reins
 - Out of lead or cross-cantering more than two strides when changing leads
 - Trotting more than three strides when making a simple lead change
 - Severe disturbance of any obstacle
- g. The following will result in a 5 (five) point penalty
- Blatant disobedience (kick, bite, buck, rear, etc.) for each refusal
- h. Placed below horses performing all maneuvers
- Eliminates maneuver
 - Incomplete maneuver
- i. The following will result in a 0 (zero) score:
- Major disobedience or schooling
 - Willful abuse
- No specific penalties will be incurred for nicks or hits on logs but deduction may be made in maneuver score.
No specific penalties will be incurred for over or under spins bit deduction may be made in maneuver score.

MWHS Rulebook revised for above section 2015, 2022



MWHS RANCH RIDING

JUDGE
CLASS
DATE

ONE (1) POINT PENALTY:

- Too slow/per gait
- Over-bridled
- Out of frame
- Break of gait at walk or jog for 2 strides or less

THREE (3) POINT PENALTY:

- Break of gait at walk or jog for more than 2 strides
- Break of gait at lope
- Wrong lead or out of lead
- Draped reins

- Out of lead or cross-cantering more than two strides when changing leads
- Trotting more than three strides when making a simple lead change
- Severe disturbance of any obstacle

FIVE (5) POINT PENALTY:

- Blatant disobedience (kick, bite, buck, rear, etc.) for each refusal

ZERO SCORE:

- Illegal equipment including hoof black, braided or banded manes, or tail extensions

- Willful abuse
- Major disobedience or schooling
- No specific penalties will be incurred for nicks/hits on logs but deduction may be made in maneuver score.

PLACED BELOW HORSES

PERFORMING ALL MANEUVERS:

- Eliminates maneuver
- Incomplete maneuver

MANEUVER SCORES - 1 1/2 Extremely Poor, - 1 Very Poor, - 1/2 Poor, 0 Correct, + 1/2 Good, + 1 Very Good, + 1 1/2 Excellent

MANEUVER DESCRIPTION		1	2	3	4	5	6	7	8	9	10	11	12	13	14	15	PENALTY TOTAL	SCORE
MANEUVER																		
DRAW	EXH#	PENALTY																
		SCORE																
DRAW	EXH#	PENALTY																
		SCORE																
DRAW	EXH#	PENALTY																
		SCORE																
DRAW	EXH#	PENALTY																
		SCORE																
DRAW	EXH#	PENALTY																
		SCORE																
DRAW	EXH#	PENALTY																
		SCORE																
DRAW	EXH#	PENALTY																
		SCORE																
DRAW	EXH#	PENALTY																
		SCORE																
DRAW	EXH#	PENALTY																
		SCORE																
DRAW	EXH#	PENALTY																
		SCORE																

JUDGES SIGNATURE _____

RANCH RIDING PATTERN NO. 1

1. Walk
2. Trot
3. Extend the trot, at the top of the arena, stop.
4. 360 turn to the left.
5. Left lead 1/2 circle, lope to the centre.
6. Change leads (simple or flying)
7. Right lead 1/2 circle
8. Extended lope up the long side of the arena (right lead)
9. Collect back to a lope around the top of the arena and back to centre
10. Break down to an extended trot.
11. Walk over poles
12. Stop and back

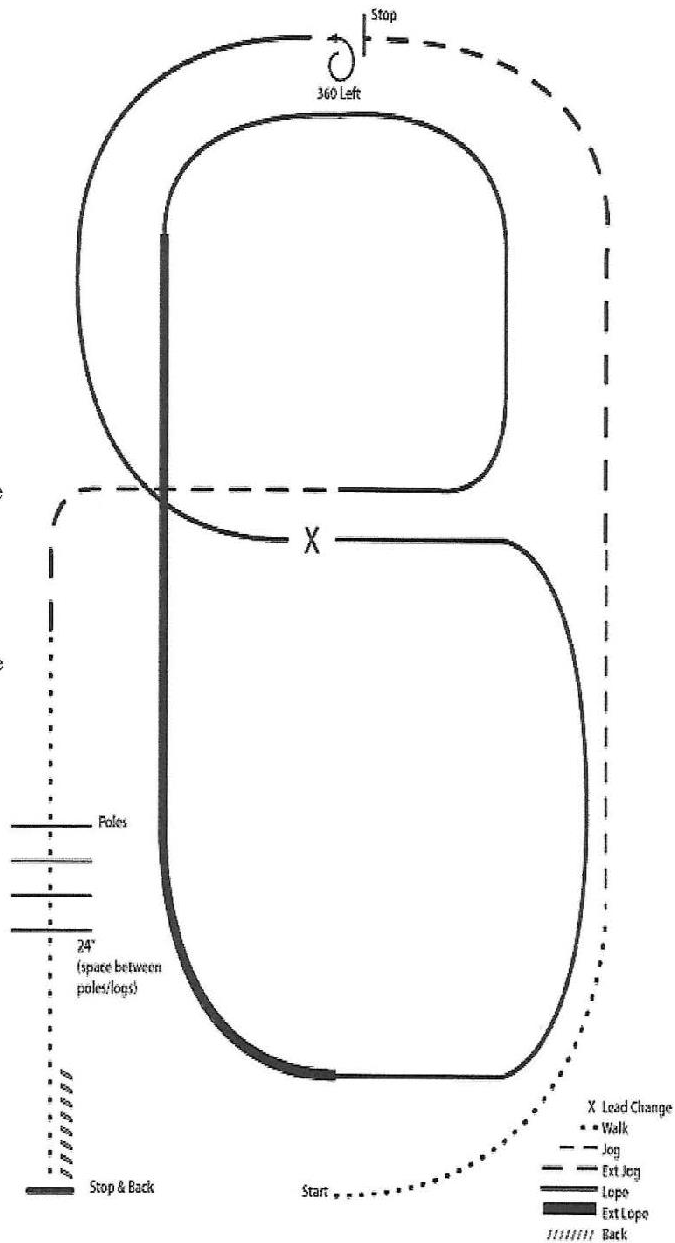

RANCH RIDING PATTERN 2

1. Walk
2. Trot
3. Extended trot
4. Left lead lope
5. Stop, 1 1/2 turn right
6. Extended lope
7. Collect to working lope - right lead
8. Change leads (simple or flying)
9. Walk
10. Walk over logs
11. Trot
12. Extended trot
13. Stop and back

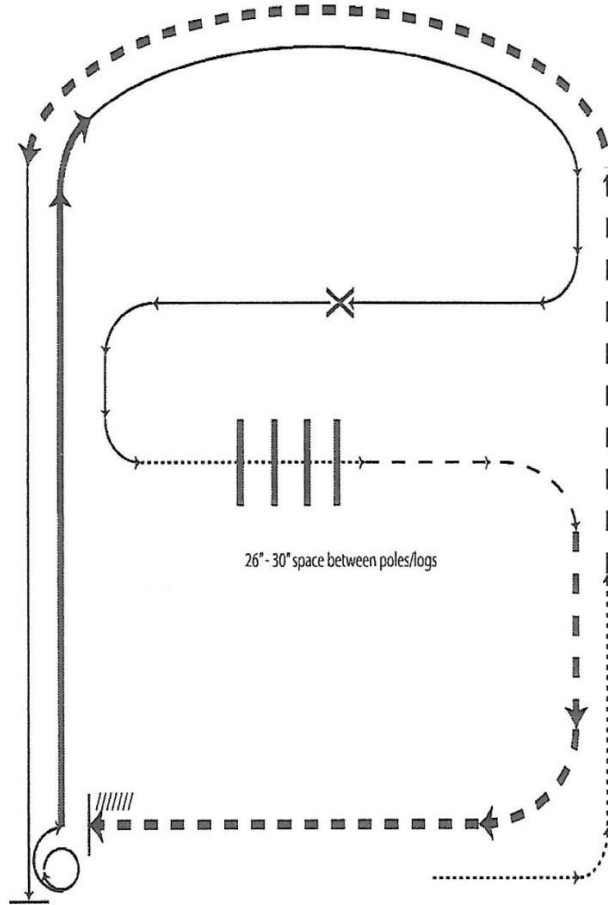

- X Lead Change
- • Walk
- - Trot
- - - Ext Trot
- — — Lope
- — — — Ext Lope
- /////// Back

RANCH RIDING PATTERN 3

1. Walk to the left around corner of the arena
2. Trot
3. Extend alongside of arena and around the corner to centre
4. Stop, side pass right
5. 360 degree turn each direction (either way first) (L-R or R-L)
6. Walk
7. Trot
8. Lope left lead
9. Extend the lope
10. Change leads (simple or flying)
11. Collect to lope
12. Extend trot
13. Stop and back

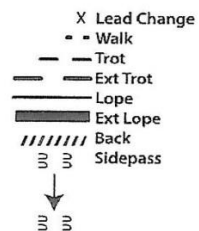
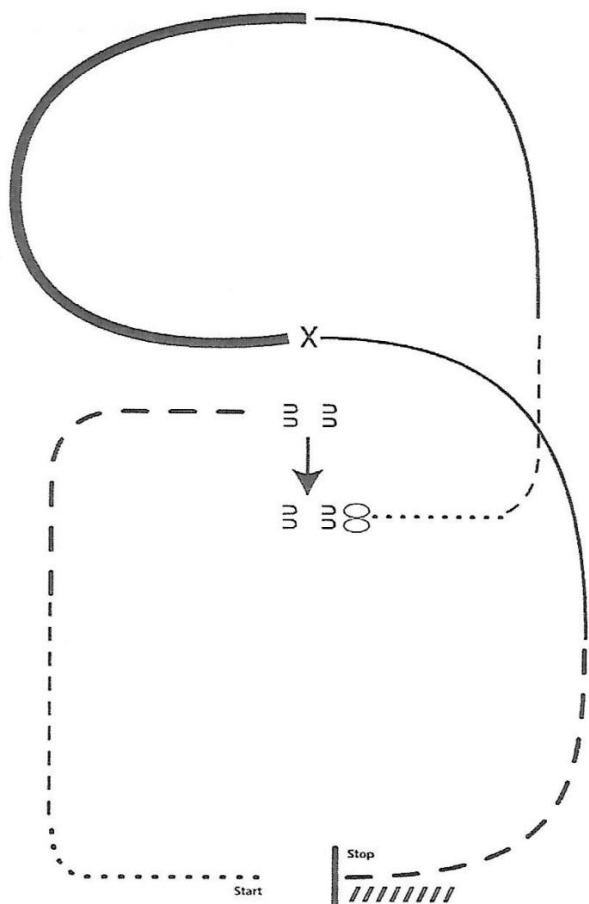

RANCH RIDING PATTERN 4

1. Walk
2. Trot serpentine
3. Lope left lead around the end of the arena and then diagonally across the arena
4. Change leads (simple or flying) and
5. Lope on the right lead around end of the arena
6. Extend lope on the straight away and around corner to the centre of the arena
7. Extend trot around corner of the arena
8. Collect to a trot
9. Trot over poles
10. Stop, do 360 degree turn each direction (either direction 1st) (L-R or R-L)
11. Walk, stop and back

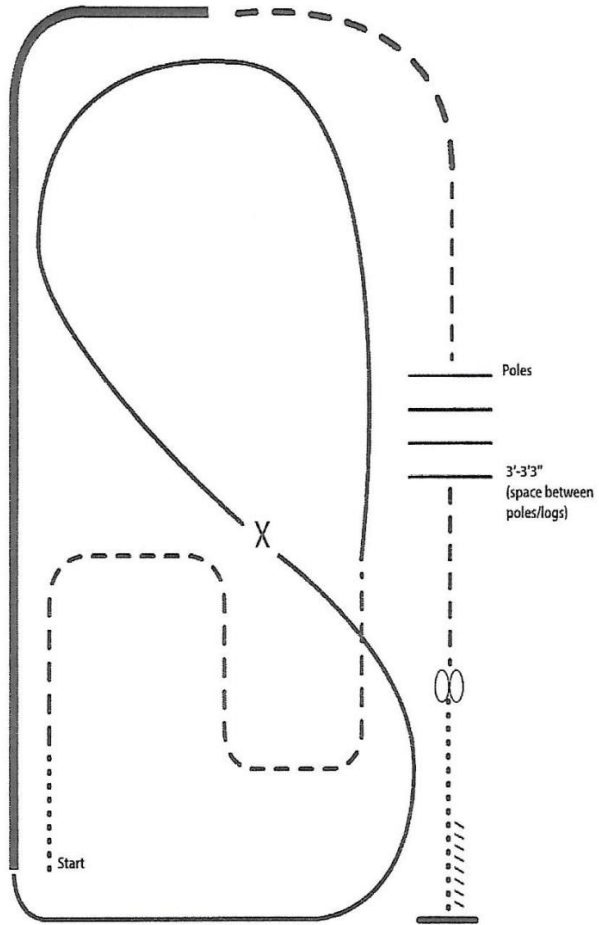

- X Lead Change
- • Walk
 - - Trot
 - — Ext trot
 - Lope
 - Ext Lope
 - ////// Back

RANCH RIDING PATTERN 5

1. Walk
2. Trot
3. Extended lope-right lead
4. Lope-right lead
5. Change leads (simple or flying)
6. Lope left lead
7. Extended trot
8. Stop, side pass left, side pass right, 1/2 way
9. Walk over logs
10. Walk
11. Trot square
12. Stop, 360° turn left, back

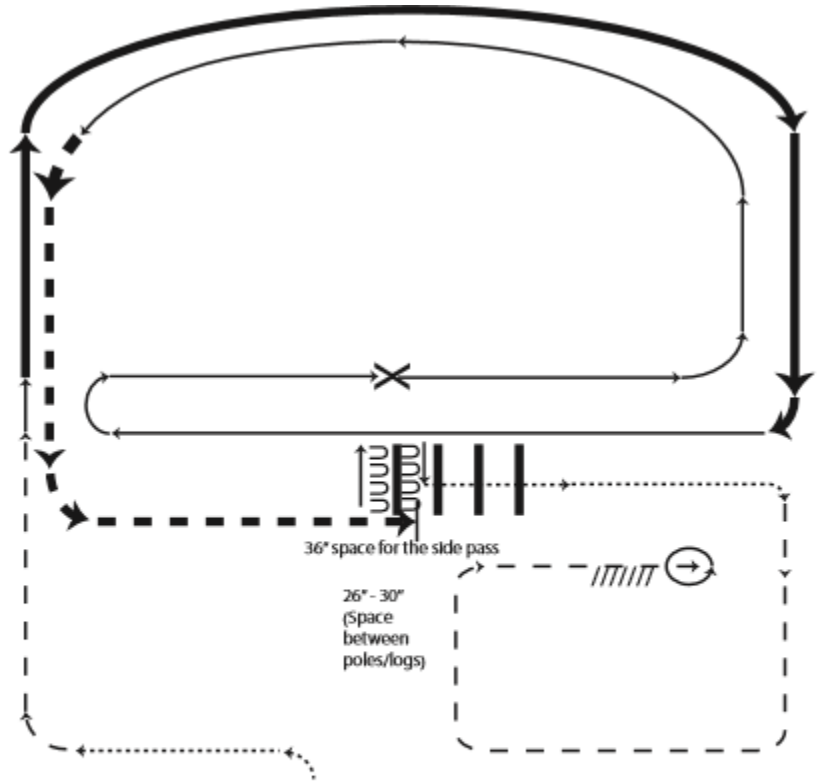

- X Lead Change
- • Walk
- - Trot
- - Ext Trot
- Lope
- Ext Lope
- ////// Back

9.0 JR. PERFORMANCE CLASSES – JR. A & B

All youth classes including Jr. B., must use the entire ring unless otherwise instructed. Jr. B ponies to stand 13.2 hands or less. Ponies will have their height measured at their first show and will be kept on record. Age of Pony is not to influence the bit used. All performance classes are to use split reins and two hands if a snaffle bit or bosal is being used. With a curb bit one hand must be used.

MWHS Rulebook revised for above section 2017

9.1 JR. A. SHOWMANSHIP AT HALTER

For rules, refer to rule 8.1 – Adult Showmanship

9.2 JR. A. ENGLISH PLEASURE

For rules, refer to rule 8.5 – Senior English Pleasure

9.3 Jr. A. WESTERN PLEASURE

For rules, refer to rule 8.3 – Senior Western Pleasure

9.4 Jr. A. WESTERN HORSEMANSHIP

For rules, refer to rule 8.2 – Adult Horsemanship

9.5 JR. B. SHOWMANSHIP

Refer to rule 8.1 – Adult Showmanship with the exception that the patterns to be used are the one provided in the rulebook. See following pages.

9.6 JR. B. WESTERN PLEASURE

Refer to rule 8.3 – Western Pleasure

9.7 JR. B. EQUITATION (English or Western)

For snaffle bit ponies, refer to rule 8.6. Height in 9.0. The age of the pony is not to influence the type of bit. All pleasure classes are to use split reins and two hands with a snaffle bit or bosal. With a curb bit one hand must be used.

Rider to be judged on seat, hands, appointments of pony and rider, suitability of pony to rider and performance of pony. Results as shown by the performance of the pony are not to be considered more important than the methods used to attain them.

Ponies are to walk, jog/ trot and lope/ canter both ways of the ring. Riders may be asked to stop and back up. Western riders should sit to the jog, not post. At the lope, the rider should be close to the saddle. The judge may ask the rider to answer simple questions on tack, equitation and anatomy of the pony.

9.8 JR. B. TRAIL

For rules, refer to rule 8.4 – Trail

9.9 WALK-JOG

Walk/ Jog on a horse over 13.2 hands (Western or English) 13 years and over

To be judged the same as Western Equitation and Hunt Seat Equitation except that only the walk and jog or trot are asked for and horses must be over 13.2 hands. Rider must not enter any other riding class, although they may show in showmanship or halter.

MWHS Rulebook revised for above section 2017

Walk/Jog Junior B on a Horse over 13.2 hands (Western or English)

To be judged the same as Western Equitation and Hunt Seat Equitation except that only the walk and jog or trot are asked for and horses must be over 13.2 hands Rider must not enter any other Jr. B. or A classes, with the exception of Jr. B or Jr. A Showmanship and Jr. B. Speed events. Also see rule 9.0 the age of the pony is not to influence the type of bit. All pleasure classes are to use split reins and two hands with a snaffle bit or bosal. With a curb bit one hand much be use.

MWHS Rulebook revised for above section 2022 to reinstate due to accidental removal

Junior B on a pony

Rider must not enter any other Jr. B. or A classes, with the exception of Jr. B. Showmanship and Jr. B. Speed events. Also see rule 9.0 The age of the pony is not to influence the type of bit. All pleasure classes are to use split reins and two hands with a snaffle bit or bosal. With a curb bit one hand must be used

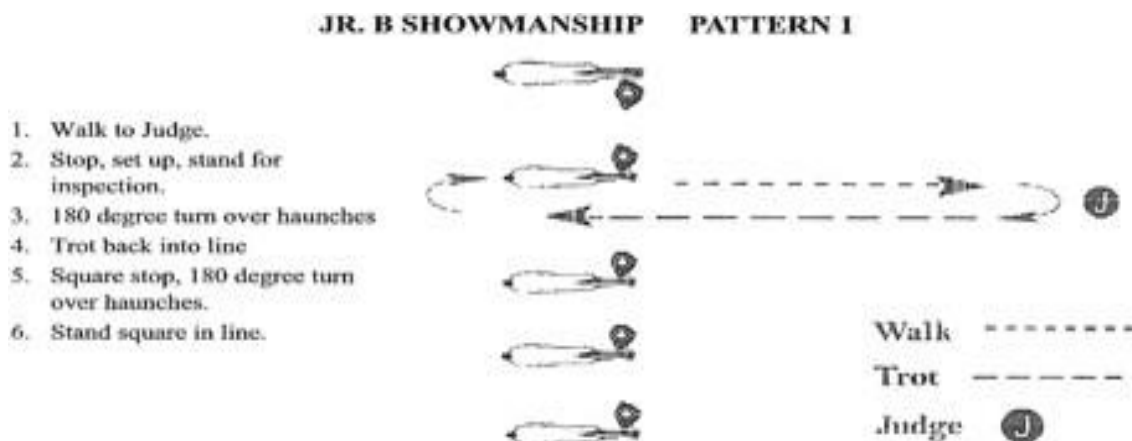

JUNIOR B SHOWMANSHIP PATTERN 2

1. Walk from A to B.
2. Trot from B to the Judge.
3. Stop and set up for inspection.
4. When dismissed, perform a 270 degree turn and walk straight away from the Judge.



JUNIOR B SHOWMANSHIP PATTERN 3

1. Begin at A. Trot from A past B.
2. Stop and perform a 90 degree turn.
3. Walk to the Judge, stop and set up for inspection.
4. When dismissed back one horse length and perform a 270 degree turn.
5. Trot to the line up.

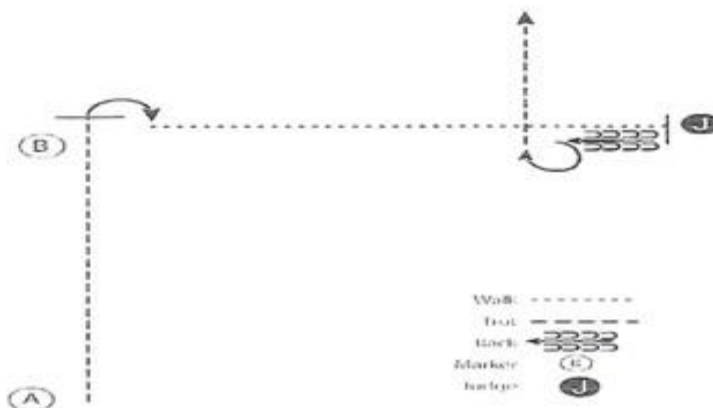

JUNIOR B SHOWMANSHIP PATTERN 4

Be ready at A.

1. When acknowledged, walk around B and around C.
2. Trot from C to Judge.
3. Stop and set up for inspection.
4. When dismissed, perform a 90 degree turn and walk away from Judge.

Follow the directions of the Ring Steward.

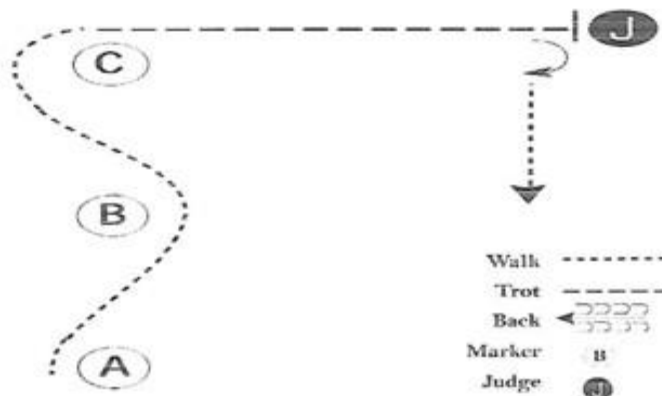

JUNIOR B SHOWMANSHIP PATTERN 5

Be ready at A.

1. Walk to B.
2. Trot to and around C to Judge.
3. Stop and set up for inspection.
4. When dismissed, back approximately one horse length.
5. Turn slightly right and walk away.

Follow the instructions of your Ring Steward.

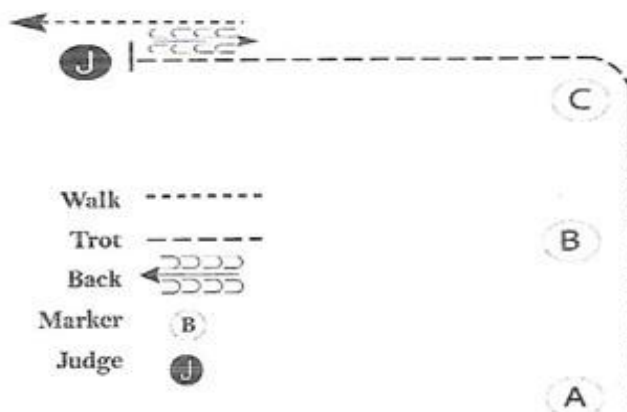

10.0 SPEED EVENT CLASSES

Refer to Rule 3.14 – Speed Event Rules. Refer to the following pages for patterns and descriptions.

10.1 CLOVERLEAF BARREL RACE

Three 45 gallon (170 liter) closed barrels must be used. The barrels are placed in a triangle, starting line to base of barrels to be 30 feet (9 meters). Each barrel must be a minimum of 15 feet (4.5 meters) from the side of the arena, except the head barrel which must be a minimum of 20 feet (6 meters) from the end. Two markers at the fence mark the start and finish line. Midpoint of the starting line to be in line with the midpoint of base barrels and head barrel. Horse enters and returns through markers or is disqualified.

COURSE: Running start, horse makes a right turn around the right hand barrel, left turn around the left barrel, left turn around head barrel and back between the midpoint of base barrels and markers to cross finish line. OR left turn around left barrel, right turn around right barrel, right turn around head barrel and back between base barrels and markers to cross the finish line.

PENALTY: 5 second penalty for each barrel knocked over.

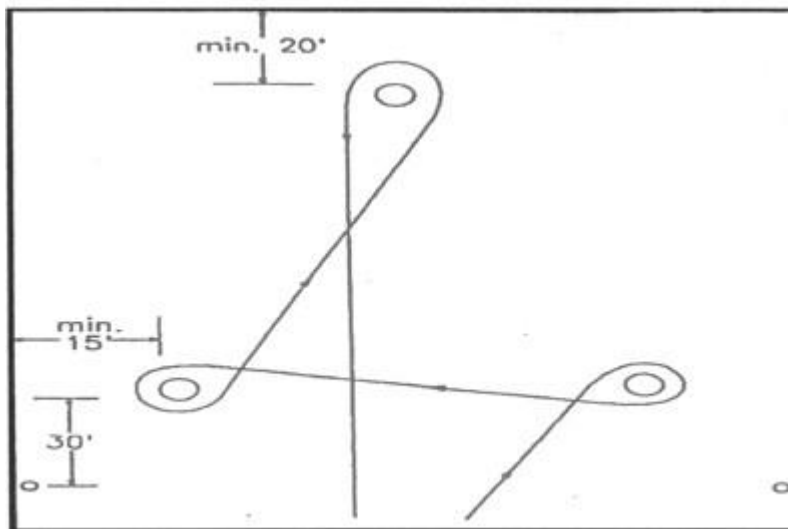

MWHS Rulebook revised for above section 1997

10.2 POLEBENDING

Six poles 6 feet (2 meters) in height and mounted on suitable bases to be used. Poles are spaced 21 feet (6.4 meters) apart, first pole to be 21 feet (6.4 meters) from the starting line.

COURSE: Running start. Rider races down one side of poles, reverses and weaves through poles, reverses and weaves back through poles again, then races down other side to finish line. Rider may start on either side of the poles.

DISQUALIFICATIONS: Off course, breaking time beam before completing run.

PENALTY: 5 second penalty for each pole knocked down.

MWHS Rulebook revised for above section 1997

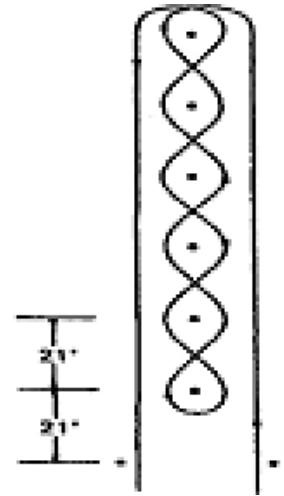

10.3 KEYHOLE

Measurements of Keyhole: entrance 5 feet (1.5 meters), 10 feet (3 meters) long into a circle 20 feet (9 meters) diameter. Start to be 150 feet (46 meters) to furthest edge of circle or back of circle to be 20 feet off end wall. 6 markers to be used for entrance, three on each of the neck, and to be 5 gallon (20 liter) highly visible pails. No lines between markers in the neck. All boundary lines of the circle to be marked in lime, sawdust or shavings.

COURSE: Running start. Rider races to keyhole, turns within circle of the keyhole and returns through opening to finish line.

DISQUALIFICATIONS: Horse stepping outside the line, knocking over marker, jumping markers or turning in neck of keyhole.

MWHS Rulebook revised for above section 1997

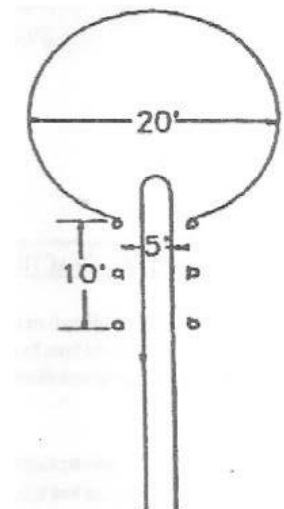

10.4 FLAG RACE

One open 45 gallon (170 liter) barrel with earth of 12 inches of straw in bottom to be placed halfway down the center of the arena. Another marker to be placed near the far end of the arena in line with the middle barrel and starting line mid-point. Distance from starting line to end marker to be 150 feet (46 meters) or at least 20 feet (9 meters) off end wall or fence. The Flag shall be a round wooden pole 1" to 1-1/4" (2.5-3 mm) in diameter, 4 feet to 4 feet 2 inches (122 cm-127 cm) in length. Taping of the handle is recommended.

COURSE: Running start. Rider races up one side of the barrel, picks up the flag, races around the end marker, deposits flag back in barrel from the opposite side that it was picked up and races across the finish line.

DISQUALIFICATIONS: Flag not in barrel, knocking over barrel or end marker.

MWHS Rulebook revised for above section 1997, 2014

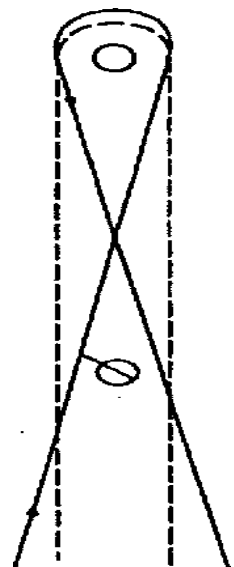

10.5 DOWN & BACK

One 45 gallon (170 liter) barrel placed in the Centre near the end of the arena.

Distance from starting line and end barrel will be 150 feet (46 meters) or at least 20 feet (9 meters) off the end all or fence.

COURSE: Running start. Rider races to end barrel, turns around it and races back to finish line.

DISQUALIFICATIONS: Knocking over barrel.

MWHS Rulebook revised for above section 1997



10.6 TEXAS SPEED AND ACTION

Three 45 gallon (170 liter) closed barrels are placed 4 feet (122 cm) apart parallel to end fence and at least 20 feet (6 meters) from end fence. Four poles mark the corners of a 20 foot (6 meter) square with the lead edge at the starting line or close to it. Course to be 150 feet (46 meters) where possible.

COURSE: Running start. Rider to race through square to barrels, go around the Centre barrel in either direction, race back to the square, turn and go back around the center barrel in the opposite direction as taken the first time and race back through the square to cross the finish line. Entire horse must be in the square when turning.

DISQUALIFICATIONS: Knocking over barrel, stepping outside the square, off course. Rider may complete course if they so wish to do so.

MWHS Rulebook revised for above section 2006, 2008

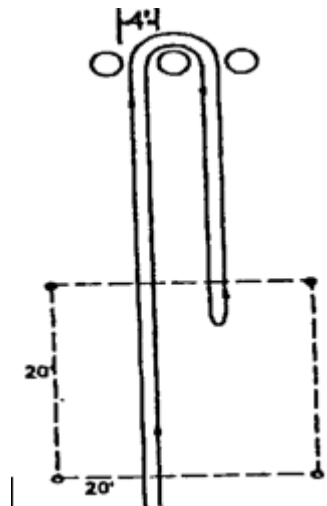

10.7 RESCUE RACE

Marker is placed a minimum of 20 feet (6 meters) from the end of the arena.

Course to be 150 feet (137 meters) where possible.

COURSE: Running start. Rider races to marker, picks up second rider at marker and races to the finish line. Second rider must wear protective helmet strapped on, but no tie is required. Both riders must be astride the horse before crossing the finish line.

DISQUALIFICATION: Failing to go around marker, knocking over the marker. Failing to have both riders astride horse when crossing the finish line.

MWHS Rulebook revised for above section 2006

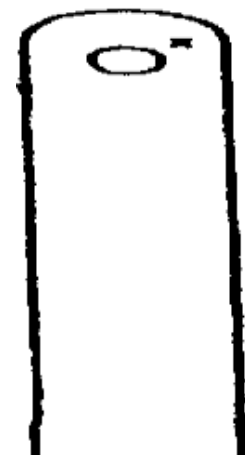

10.8 DOUBLE FIGURE EIGHT

Three 45 gallon (170 liter) closed barrels are set up in an inverted triangle, with the head barrel closest to the starting point (reverse Cloverleaf Barrel Race).

COURSE: Horse enters through starting markers to the right of head barrel, to the left barrel, makes a right turn around it, back to the head barrel, makes a left turn around it and up to the bright barrel, makes a right turn around it, back to pass the head barrel on the opposite side as when starting and through the finish line markers OR vice versa, starting to the left of the head barrel.

DISQUALIFICATION: Off course, knocking over barrel.

MWHS Rulebook revised for above section 1997

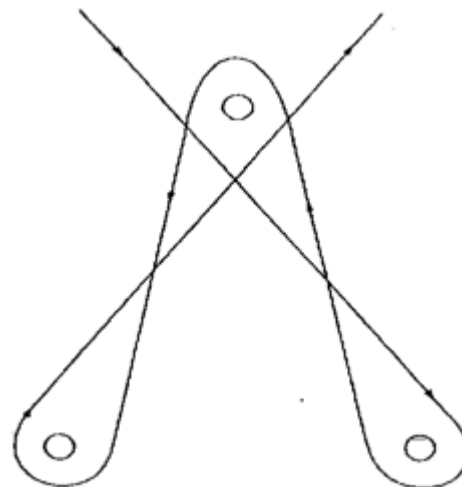

10.9 COMBINATION GAME

Five poles (as in Polebending) are placed on each side of the arena, 21 feet (6.4 meters) apart where possible, minimum of 18 feet (5.5 meters) and two open barrels (as in Flag Race) are placed one in the center and one at the far end of the arena.

COURSE: Rider races to pick up the flag from the near barrel, places it in the end barrel, then turns to the right or left and polebends through the poles on that side of the arena, one direction only, cross the arena to polebend through the poles on the other side of the arena, pick up the flag from the end barrel and place it back in the first barrel and race across the finish line.

DISQUALIFICATION: Off course, except that the rider may circle and try to pick up the flag once again at each flag pick up. Two misses at the same barrel disqualifies. Dismounting or knocking over any marker or barrel, flag not in barrel.

MWHS Rulebook revised for above section 1997

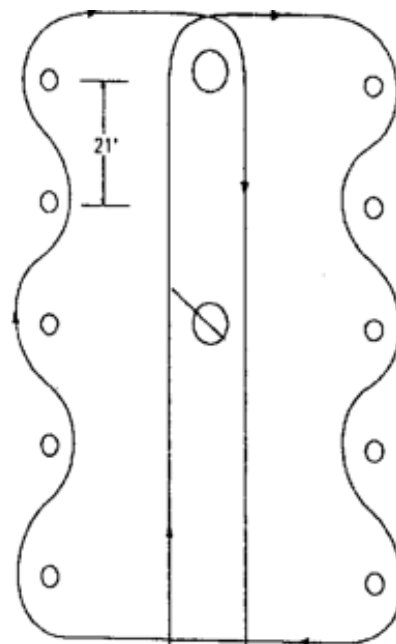

11.0 JR. A. & JR. B. SPEED EVENTS

Refer to Rule 3.14 – General Timed Events rule

11.1 JR. A & B CLOVER LEAF BARREL RACE

Refer to Rule 10.1 – Clover Leaf Barrel Race

11.2 JR. A. & B POLEBENDING

Refer to Rule 10.2 – Polebending

11.3 JR. A & B KEYHOLE

Refer to Rule 103 – Keyhole race

11.4 JR. A. FLAG RACE

Refer to Rule 10.4 – Flag race

11.5 JR. B. DOWN & BACK

Refer to Rule 10.5 – Down and Back



Mid-Western Ontario Horseman's Society
Youth Scholarship Application
Rules of Application

Two \$1000.00 scholarships will be presented to the selected applicants annually, however, M.W.H.S. may at any time change the number of scholarship recipients and the amount awarded.

12.0 Youth Scholarship

1. Applicants must be **17** years of age but not have reached their **25th** birthday as of January 1st of the current year.
2. **Applicants must have a current M.W.H.S. membership as well as been a member of M.W.H.S. within the past five years.**
 - a. Applicants must volunteer at two M.W.H.S. functions prior to the application deadline, such as horse shows, clinics, banquet, fundraisers, preparation for MWHS events such as judge's cards and other duties being performed by committees. Volunteer hours for MWHS may be from a previous year.
MWHS Rulebook revised for above section 2017
3. The goal of this Scholarship program is to benefit as many youth as possible; previous recipients are not eligible to reapply for the scholarship.
4. Applicants must provide current or most recent transcript of their Ontario Scholastic Record, and must accurately complete in full the application supplied. ***Students who have graduated from High School and are currently enrolled in post graduate education should include a current transcript and their High School transcript.***
5. Only successful applicants will be required to submit a recent colour photo ***approx.2.5 x 3.5 inch*** preferably with their horse. Photos will not be returned. The selected applicants' photo may be published.
6. Applications must be received no later than **third Sunday of September** of the current year.
7. Applicants must include a total of two reference letters. Adults who are at least 21 years of age and not the applicants' legal guardian or a relative must write letters. Each reference must state how he or she knows the applicant and for how long. The reference letters must be from references listed on the application form. They should have specific, personal knowledge of applicants' activities and must be able to validate them. M.W.H.S. reserves the right to contact all references listed on this application.
8. All applicants must submit a 500-word essay to explain how involvement with horses has affected and enhanced their lives. ***Essays should be typed and double spaced.***
9. The selection committee may invite the top applicants to a personal interview.
10. Should a winning applicant be currently attending High School, the scholarship will be held in trust by M.W.H.S. until the recipient is enrolled in post secondary education. The recipient must be enrolled as a full time student during the semester for which the scholarship is funded. Should the recipient not pursue post-secondary education by his/her **24th** birthday, he/she must forfeit the scholarship.
11. The scholarships will be presented at the M.W.H.S. Annual Banquet. The recipient is expected to attend the banquet to receive the scholarship.
12. Scholarships can be used towards tuition, books, board or any other miscellaneous school needs.



**Mid-Western Ontario Horseman's Society
Youth Scholarship Application
Scoring Criteria**



Essays to count for 40% of Total

- ❖ Grammar and presentation: **10%**
- ❖ Content: **30%**



Application to count for 60% of Total

- ❖ Academic Transcripts: **15%**
- ❖ Horse Related Activities: **15%** (May include involvement in saddle club or horse association)
- ❖ Extra Curricular Activities: **10%** (May include other sports activities, church, school or volunteer programs)
- ❖ Reference Letters: **10%**
- ❖ **MWHS Participation 10%**